

8-Button Network Control Panel



Version Information

Version	Release Date	Notes
4	Jan 2024	Updated warranty information

Sales, Marketing, and Customer Support

Main Office

Atlona Incorporated
70 Daggett Drive
San Jose, CA 95134
United States

Office: +1.408.962.0515

Sales and Customer Service Hours
Monday - Friday: 6:00 a.m. - 4:30 p.m. (PST)

<https://atlona.com/>

International Headquarters

Atlona International AG
Tödistrasse 18
8002 Zürich
Switzerland

Office: +41.43.508.4321

Sales and Customer Service Hours
Monday - Friday: 09:00 - 17:00 (UTC +1)

Operating Notes



IMPORTANT: Visit <https://www.atlona.com/product/at-anc-108d> for the latest firmware updates and User Manual.

Warranty



To view the product warranty, use the following link or QR code:

<https://atlona.com/warranty/>

Safety and Certification



CAUTION: TO REDUCE THE RISK OF ELECTRIC SHOCK DO NOT OPEN ENCLOSURE OR EXPOSE TO RAIN OR MOISTURE. NO USER-SERVICEABLE PARTS INSIDE REFER SERVICING TO QUALIFIED SERVICE PERSONNEL.



The exclamation point within an equilateral triangle is intended to alert the user to the presence of important operating and maintenance instructions in the literature accompanying the product.



The information bubble is intended to alert the user to helpful or optional operational instructions in the literature accompanying the product.

1. Read these instructions.
2. Keep these instructions.
3. Heed all warnings.
4. Follow all instructions.
5. Do not use this product near water.
6. Clean only with a dry cloth.
7. Do not block any ventilation openings. Install in accordance with the manufacturer's instructions.
8. Do not install or place this product near any heat sources such as radiators, heat registers, stoves, or other apparatus (including amplifiers) that produce heat.
9. Do not defeat the safety purpose of a polarized or grounding-type plug. A polarized plug has two blades with one wider than the other. A grounding type plug has two blades and a third grounding prong. The wide blade or the third prong are provided for your safety. If the provided plug does not fit into your outlet, consult an electrician for replacement of the obsolete outlet.
10. Protect the power cord from being walked on or pinched particularly at plugs, convenience receptacles, and the point where they exit from the product.
11. Only use attachments/accessories specified by Atlona.
12. To reduce the risk of electric shock and/or damage to this product, never handle or touch this unit or power cord if your hands are wet or damp. Do not expose this product to rain or moisture.
13. Unplug this product during lightning storms or when unused for long periods of time.
14. Refer all servicing to qualified service personnel. Servicing is required when the product has been damaged in any way, such as power-supply cord or plug is damaged, liquid has been spilled or objects have fallen into the product, the product has been exposed to rain or moisture, does not operate normally, or has been dropped.



FCC Compliance

FCC Compliance and Advisory Statement: This hardware device complies with Part 15 of the FCC rules. Operation is subject to the following two conditions: 1) this device may not cause harmful interference, and 2) this device must accept any interference received including interference that may cause undesired operation. This equipment has been tested and found to comply with the limits for a Class A digital device, pursuant to Part 15 of the FCC Rules. These limits are designed to provide reasonable protection against harmful interference in a commercial installation. This equipment generates, uses, and can radiate radio frequency energy and, if not installed or used in accordance with the instructions, may cause harmful interference to radio communications. However there is no guarantee that interference will not occur in a particular installation. If this equipment does cause harmful interference to radio or television reception, which can be determined by turning the equipment off and on, the user is encouraged to try to correct the interference by one or more of the following measures: 1) reorient or relocate the receiving antenna; 2) increase the separation between the equipment and the receiver; 3) connect the equipment to an outlet on a circuit different from that to which the receiver is connected; 4) consult the dealer or an experienced radio/TV technician for help. Any changes or modifications not expressly approved by the party responsible for compliance could void the user's authority to operate the equipment. Where shielded interface cables have been provided with the product or specified additional components or accessories elsewhere defined to be used with the installation of the product, they must be used in order to ensure compliance with FCC regulations.

Copyright, Trademark, and Registration

© 2024 Atlona Inc. All rights reserved. "Atlona" and the Atlona logo are registered trademarks of Atlona Inc. Pricing, specifications and availability subject to change without notice. Actual products, product images, and online product images may vary from images shown here.

All other trademark(s), copyright(s), and registered technologies mentioned in this document are the properties of their respective owner(s).

Table of Contents

Introduction	8
Features	8
Package Contents	8
Panel Description	9
Installation	10
Power Connector	10
Connection Instructions	11
Connection Diagram	12
Wallplate Installation	13
Configuration and Management Interfaces	14
Web Server	14
System Settings tab	14
Device Settings tab	16
Command Settings tab	17
Macro Settings tab	18
Extension Macro tab	19
Message Polling tab	20
Time Settings tab	21
Schedule tab	22
Login Config tab	23
Device Operation	24
IP Configuration	24
Resetting to Factory Defaults	24
Accessing the Web Server	25
Getting the IP Address	25
Logging In	26
System Configuration	27
Changing the Network IP Mode	27
Changing the Telnet Port	28
Setting the Host Name	28
Telnet Login Mode	29
Adjusting Telnet Timeout	29
Downloading System Configuration	30
Restoring System Configuration	31
Resetting to Factory-Default Settings	32
Rebooting the AT-ANC-108D	33
Setting the System Date and Time	34
Setting Local Time	34
Setting Daylight Savings Time (DST)	36
Password Management	37
Device Configuration	38
Button Orientation	38
Adding a Device	39
Command Configuration	41
Creating Macros	44
Configuring Extension Macros	50
Message Polling	53
Testing Macros	56
Velocity	58
Using the AMS Device Manager	58
Appendix	62
Updating the Firmware	62
Specifications	64

Introduction

The Atlona AT-ANC-108D is an 8-button network control panel for Atlona IP-based single output channel switchers. It is designed for easy configuration using the free Atlona Management System (AMS) software resource as well as the embedded web server. The ANC-108D only requires a single category cable, from a PoE-equipped network switch, to deliver both control signal and power, and provide fast, hassle-free installation. Configuration is also fast. Simply download a configuration file from within AMS, or use the embedded web server, for Atlona single output switchers such as the OMEGA Series, HDVS-200 Series, HDVS-300 Kit, SW Series, AT-UHD-CLSO-601, or AT-UHD-CLSO-612ED.

Even with automatic input switching and display control on many of our AV switchers, presenters still want a visual means of changing inputs, operating displays and adjusting volume. The ANC-108D backlit panel provides a user-friendly means of controlling the AV in a meeting room or classroom. System designers need a cost-effective point of control to meet those needs without worrying about complex control system coding. The ANC-108D, working with AMS, meets both of these demands. Regardless of the Atlona IP-based switcher designed into the meeting space or classroom, with the ANC-108D the AV operator will always have a consistent control interface from room to room.

Combined with Atlona IP-controllable switching products for huddle spaces, classrooms and conference rooms, the network control panel acts as a remote control to send IP commands to the switcher. The switcher in turns acts on those commands or translates the IP commands into RS-232 commands to control external devices such as displays to create a seamless AV system. The ANC-108D fits into a US one-gang junction box and is compatible with Decora-style wallplates.

Features

- Remote control panel for Atlona IP-based products
- Fast-installing, single-cable integration
- Easy to configure with either the built-in web server or AMS and downloadable templates
- Eight soft-touch, backlit buttons
- Remotely-powered via PoE (Power over Ethernet)
- Installer-customizable, pre-cut label sheets
- Fits US one-gang junction box with Decora™ wallplate
- Award-winning 10 year limited product warranty

Package Contents

- 1 x AT-ANC-108D
- 1 x White Decora faceplate
- 1 x Blank button template
- 1 x Pre-defined button template
- 1 x Installation Guide

Panel Description

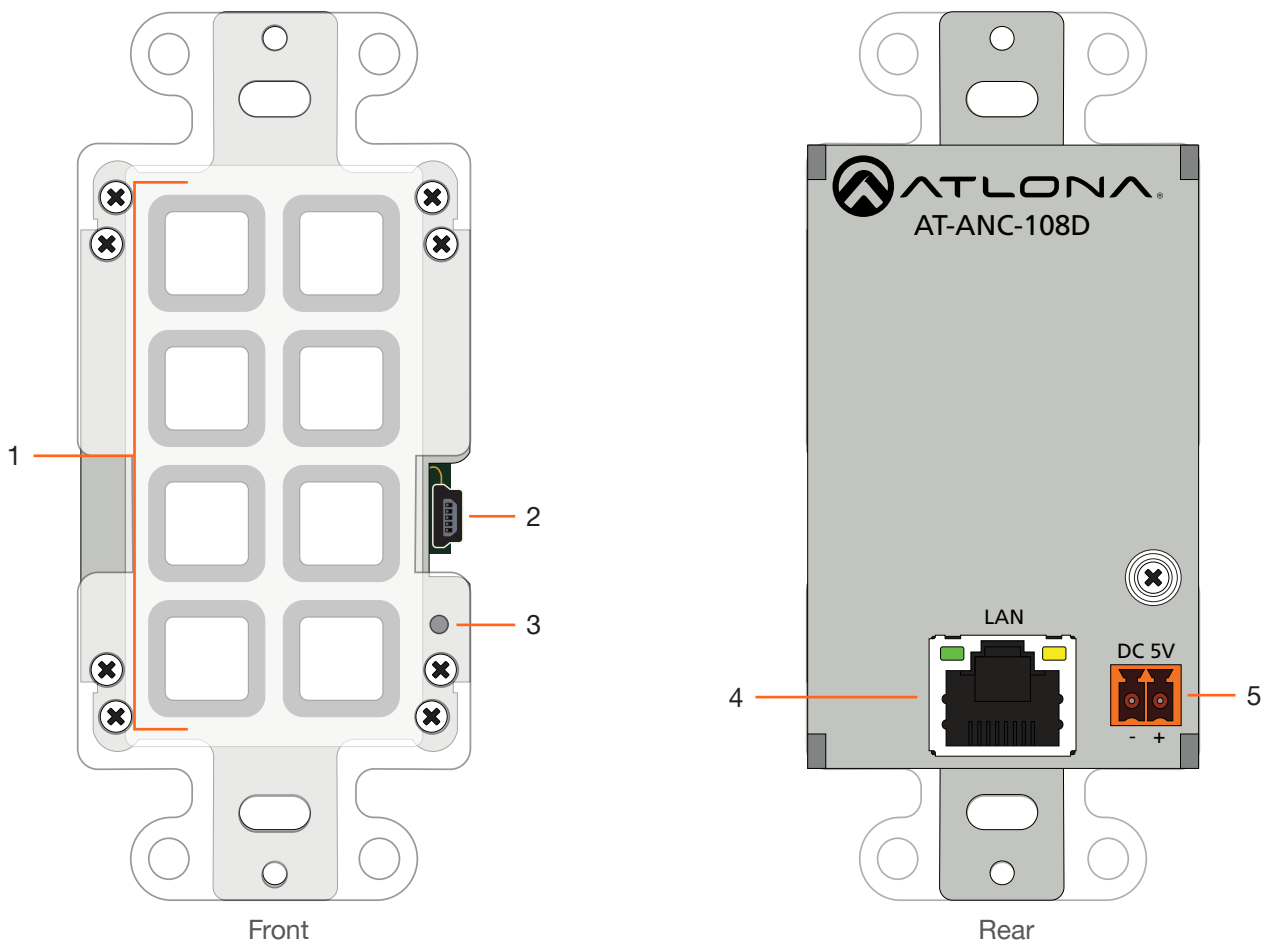

1 Push Buttons

This set of eight programmable push buttons can be defined using the built-in web interface.

2 Mini-USB

This port is used to update the unit, manually. Atlona recommends using the built-in web server for updating the firmware on the AT-ANC-108D. Refer to [Updating the Firmware \(page 60\)](#) for more information.

3 Reset Button

Press this button to reset the unit. Refer to [Resetting to Factory Defaults \(page 22\)](#) for more information.

4 LAN

Connect an Ethernet cable from this port to the Local Area Network (LAN).

5 DC 5V

Connect the optional 5V DC power supply (not included) to this port, if necessary. If the AT-ANC-108D is connected to a PoE-capable switch, the 5V DC power supply is not required.

Installation

Power Connector



NOTE: The DC 5V connector is only required if the AT-ANC-108D is not connected to a PoE-capable network switch. If a PoE-capable switch is unavailable, refer to the instructions below to connect the power supply. The power supply and captive screw connector are not included. To purchase the power supply (part no. AT-PS-54-C), contact Atlona.

Locate the included orange 2-pin captive screw terminal block and wire the included captive screw terminal block, as shown below. Do not use high-torque devices, when securing the wires to the terminal block, as this may damage the screws and/or the block.

1. Insert the wires into the correct terminal on the included captive screw terminal block, as shown below.
2. Tighten the screws to secure the wires. Do not use high-torque devices as this may damage the screws and/or terminal block.

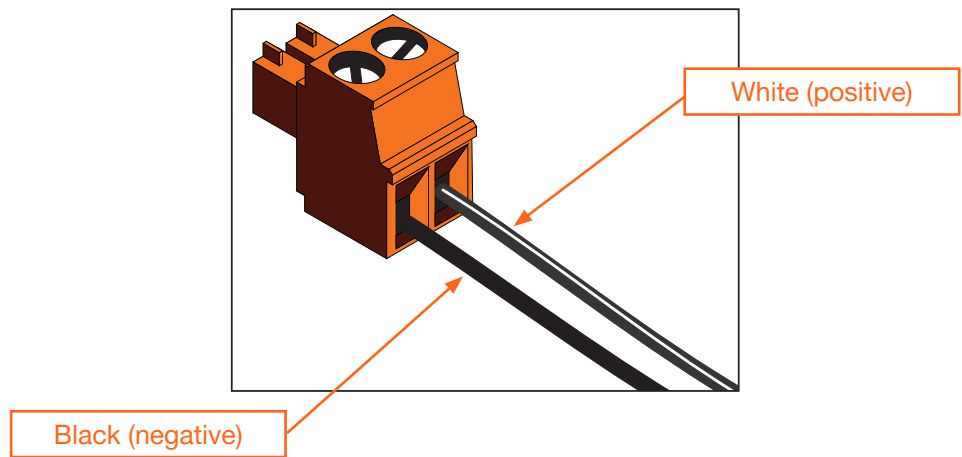
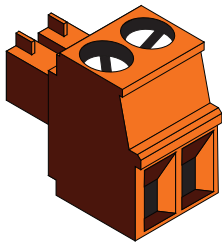

Connection Instructions

1. Connect an Ethernet cable, from the **LAN** port, on the rear of the unit, to one of the following devices. Ethernet cables should use EIA/TIA-568B termination:
 - a. PoE-compatible switch.
 - b. Atlona Power Over Ethernet Mid-Span Power Supply (AT-PS-POE). Use this option if the system endpoint is not capable of supplying power to the AT-ANC-108D.



IMPORTANT: Shielded (STP) cables are recommended, in order to minimize signal noise and interference.

2. Complete the installation of the AT-ANC-108D into the electrical box or mud ring. Refer to the [Wallplate Installation \(page 11\)](#) if necessary.

Connection Diagram

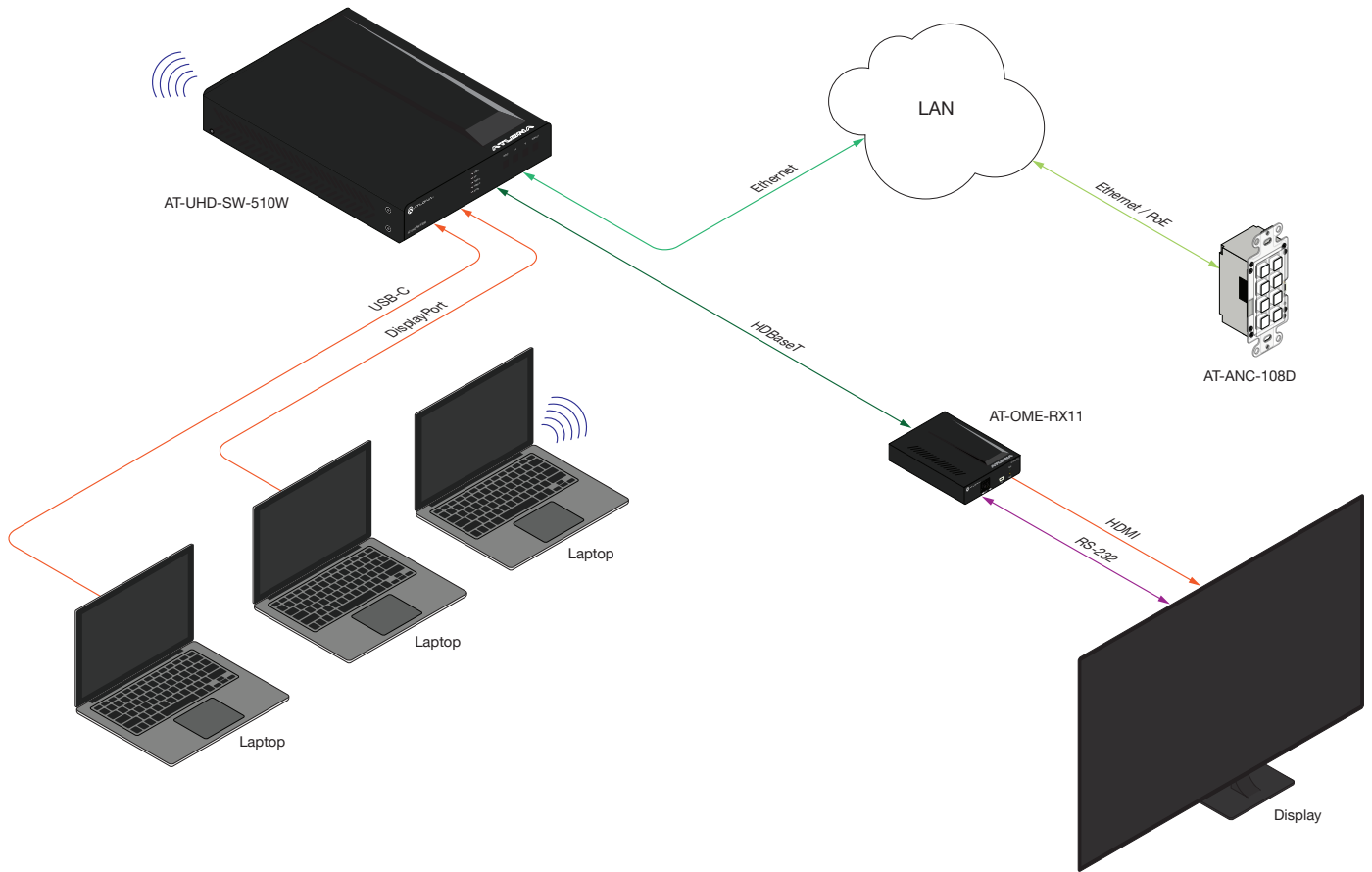

Wallplate Installation

1. Install the mud ring/electrical box (not shown in illustration) as required, then attach the AT-ANC-108D to the mud ring/electrical box assembly.
2. Connect the HDBaseT cable to the LAN port on the rear of the AT-ANC-108D.
3. Install the AT-ANC-108D into the mud ring/electrical box, using the two included screws and secure it in place with a regular screwdriver. Do not overtighten or use high-torque devices to secure the wallplate to prevent damage to the wall plate and/or the AT-ANC-108D mounting plates.

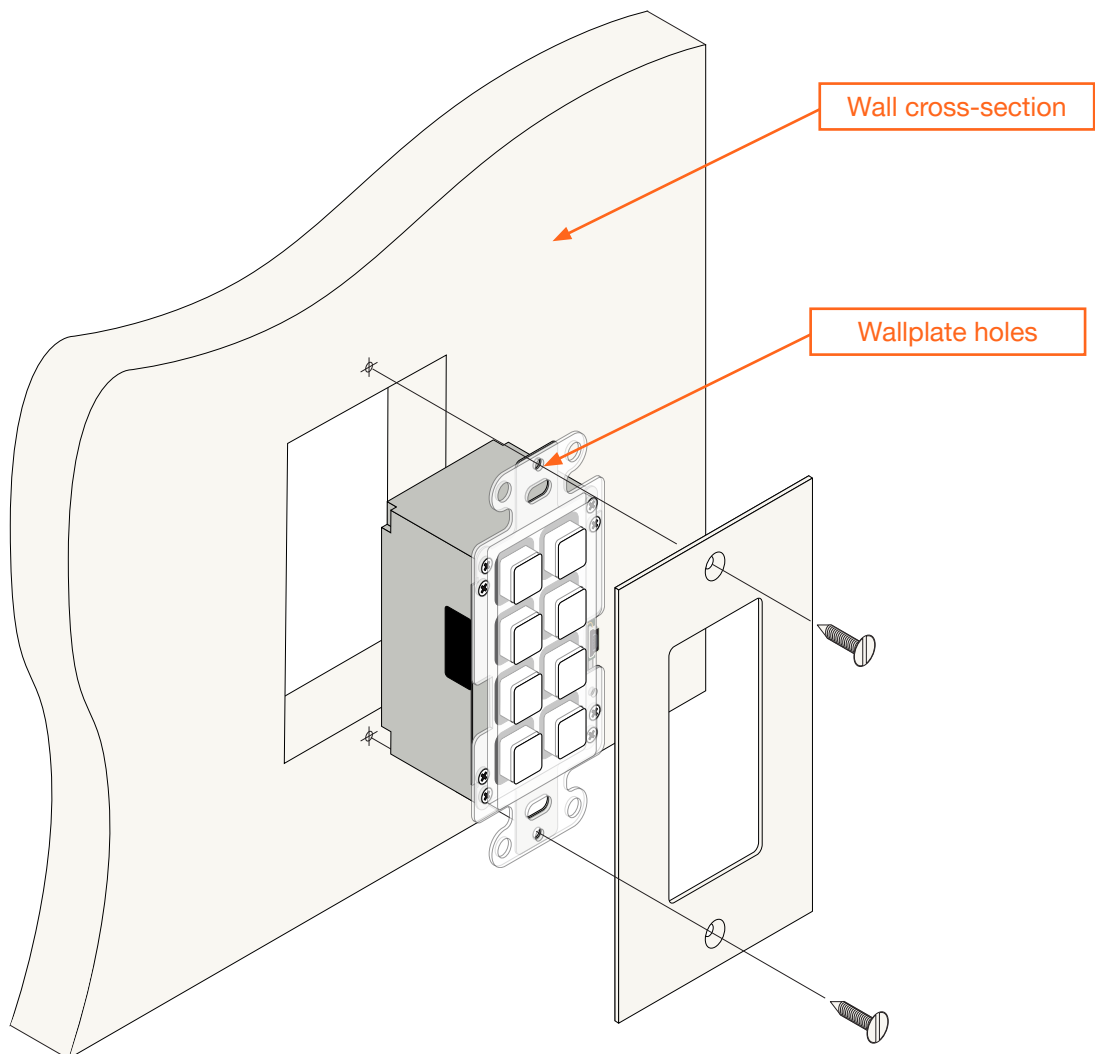

Configuration and Management Interfaces

Web Server

The AT-ANC-108D provides a built-in web server for easy configuration and control of the AT-ANC-108D . Refer to [Accessing the Web Server \(page 23\)](#) for more information.

System Settings tab

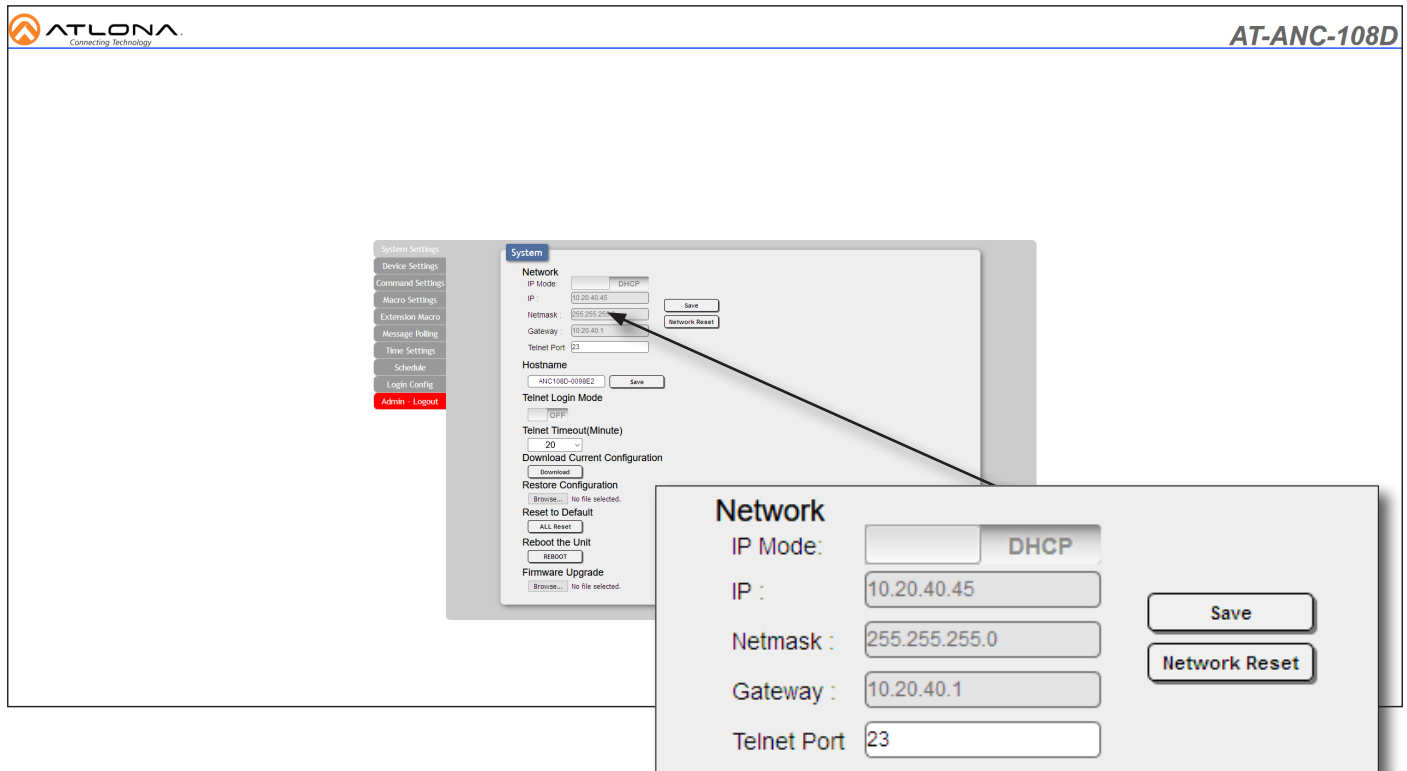

IP Mode

Click this toggle switch to set the AT-ANC-108D to **DHCP** or **STATIC IP** mode. The default setting is **DHCP** mode.

IP

Enter the IP address of the AT-ANC-108D in this field. This field will only be available when **IP Mode** is set to **STATIC IP**. The default static IP address of the AT-ANC-108D is 192.168.1.50.

Netmask

Enter the subnet mask of the AT-ANC-108D in this field. This field will only be available when **IP Mode** is set to **STATIC IP**.

Gateway

Enter the gateway (router) IP address in this field. This field will only be available when **IP Mode** is set to **STATIC IP**.

Telnet Port

Enter the desired Telnet port (for Telnet sessions) in this field. The default port is 23.

Save

Click this button to commit all network changes.

Network Reset

Click this button to reset network setting to factory-default.

Configuration and Management Interfaces

Telnet Login Mode

Click this toggle switch to set the Telnet Login Mode to **ON** or **OFF**. If set to **ON**, then login credentials (same as web server) will be required when starting a Telnet session.

Telnet Timeout

Click this drop-down list to select the timeout interval in minutes. Range is: 1 to 1000 seconds.

Download Current Configuration

Click the **Download** button to save the current system configuration to a local file.

Restore Configuration

Click the **Browse...** button to select a configuration file to restore. Click the **Restore** button to upload the configuration file to the AT-ANC-108D. Restoring a configuration file will erase the current unit configuration.

Hostname

Telnet Login Mode
 OFF

Telnet Timeout(Minute)

Download Current Configuration

Restore Configuration
 No file selected.

Reset to Default

Reboot the Unit

Firmware Upgrade
 No file selected.

Reset to Default

Click the **ALL Reset** button to reset the AT-ANC-108D to factory-default settings. All current configuration settings will be lost and the unit will be set to DHCP network mode.

Reboot the Unit

Click the **REBOOT** button to perform a soft reboot of the AT-ANC-108D.

Firmware Update

Click the **Choose File** button to begin the firmware update procedure.

Configuration and Management Interfaces

Device Settings tab

This tab allows devices to be added to the AT-ANC-108D for control. Refer to [Adding a Device \(page 37\)](#) for more information.

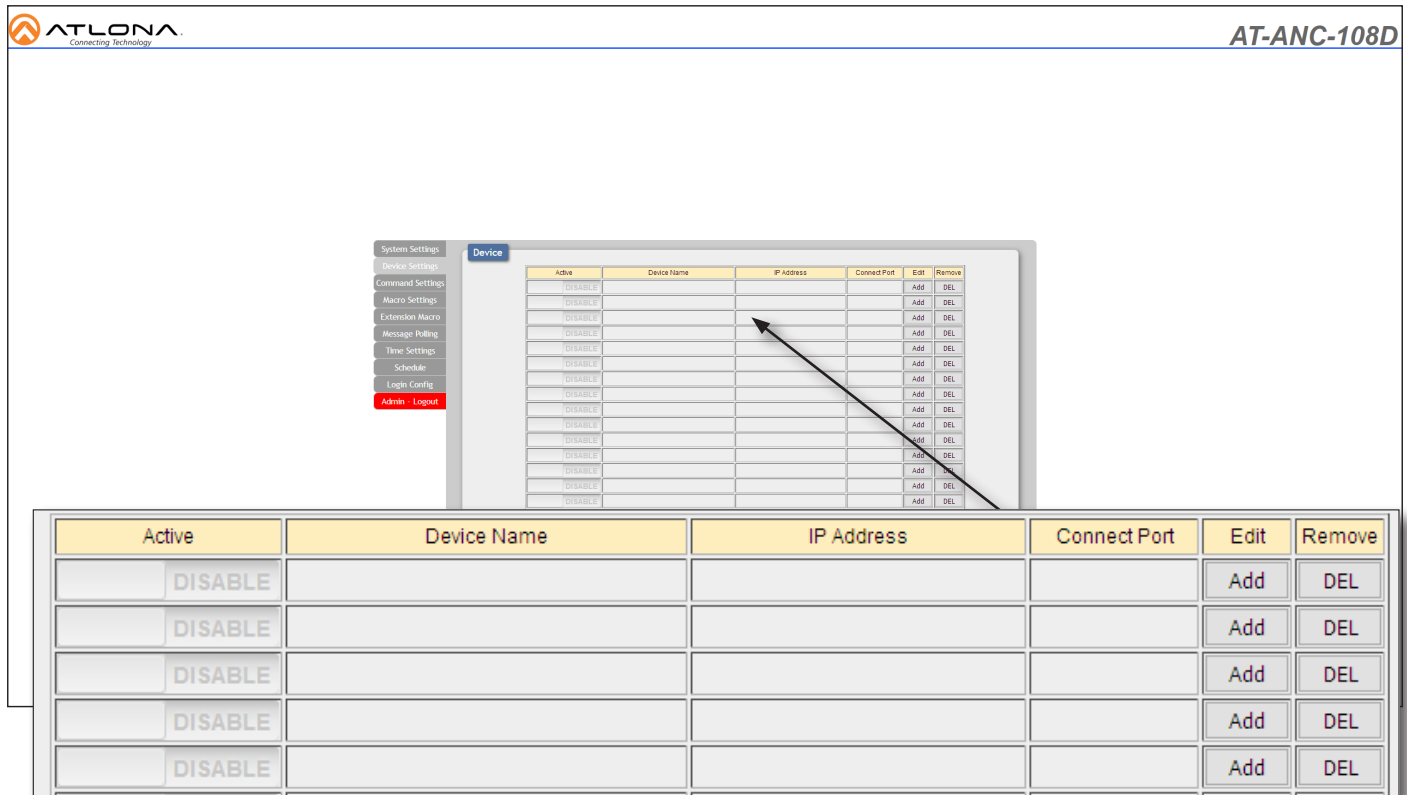

Active	Device Name	IP Address	Connect Port	Edit	Remove
DISABLE				Add	DEL
DISABLE				Add	DEL
DISABLE				Add	DEL
DISABLE				Add	DEL
DISABLE				Add	DEL
DISABLE				Add	DEL
DISABLE				Add	DEL
DISABLE				Add	DEL
DISABLE				Add	DEL
DISABLE				Add	DEL
DISABLE				Add	DEL
DISABLE				Add	DEL
DISABLE				Add	DEL
DISABLE				Add	DEL
DISABLE				Add	DEL
DISABLE				Add	DEL
DISABLE				Add	DEL
DISABLE				Add	DEL
DISABLE				Add	DEL
DISABLE				Add	DEL
DISABLE				Add	DEL
DISABLE				Add	DEL

Active

Click this toggle switch to **ENABLE** or **DISABLE** the added device.

Device Name

Displays the device name when a device has been added.

IP Address

Displays the IP address of the added device.

Connect Port

Displays the Telnet port of the connected device.

Edit

Click the **Add** button to add a device to the AT-ANC-108D.

Remove

Click the **DEL** button to delete a device from the list.

Configuration and Management Interfaces

Command Settings tab

This tab allows commands to be added, deleted, or edited. Refer to [Command Configuration \(page 39\)](#) for more information.

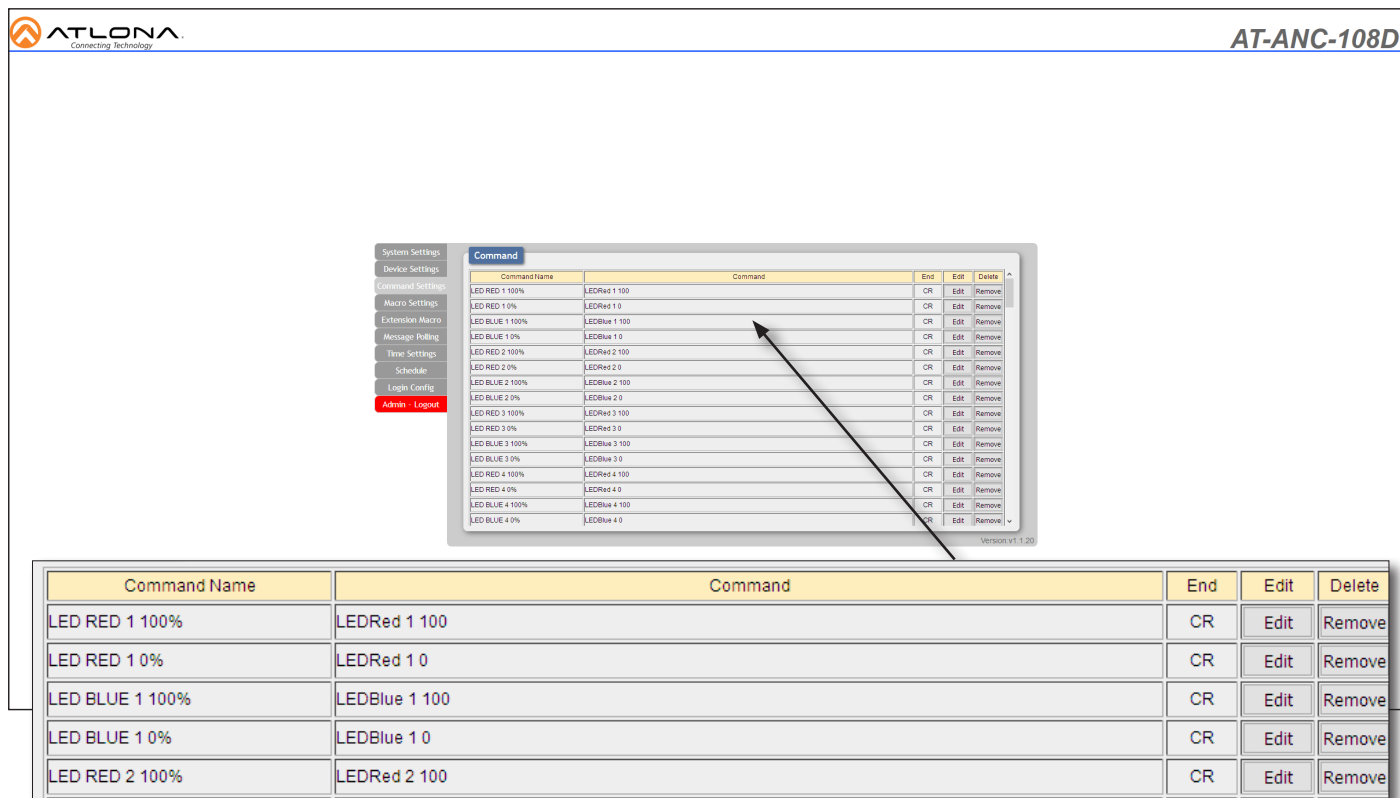

Command Name	Command	End	Edit	Delete
LED RED 1 100%	LEDRed 1 100	CR	Edit	Remove
LED RED 1 0%	LEDRed 1 0	CR	Edit	Remove
LED BLUE 1 100%	LEDBlue 1 100	CR	Edit	Remove
LED BLUE 1 0%	LEDBlue 1 0	CR	Edit	Remove
LED RED 2 100%	LEDRed 2 100	CR	Edit	Remove
LED RED 2 0%	LEDRed 2 0	CR	Edit	Remove
LED BLUE 2 100%	LEDBlue 2 100	CR	Edit	Remove
LED BLUE 2 0%	LEDBlue 2 0	CR	Edit	Remove
LED RED 3 100%	LEDRed 3 100	CR	Edit	Remove
LED RED 3 0%	LEDRed 3 0	CR	Edit	Remove
LED BLUE 3 100%	LEDBlue 3 100	CR	Edit	Remove
LED BLUE 3 0%	LEDBlue 3 0	CR	Edit	Remove
LED RED 4 100%	LEDRed 4 100	CR	Edit	Remove
LED RED 4 0%	LEDRed 4 0	CR	Edit	Remove
LED BLUE 4 100%	LEDBlue 4 100	CR	Edit	Remove
LED BLUE 4 0%	LEDBlue 4 0	CR	Edit	Remove

Command Name

Displays the name of the command.

Command

Displays the command line string for the command name.

End

Displays the terminating character for the command string.

Edit

Click the Edit button to modify the settings of an existing command.

Delete

Click the **Remove** button to delete a command from the list.

Add (not shown)

Click the Add button to add a new command to the AT-ANC-108D. The **Add** button is only displayed on empty rows. Once a new command is added, the **Add** button for that row will change to an **Edit** button.

Configuration and Management Interfaces

Macro Settings tab

This tab allows the editing and creation of macro. Refer to [Creating Macros \(page 42\)](#) for more information.

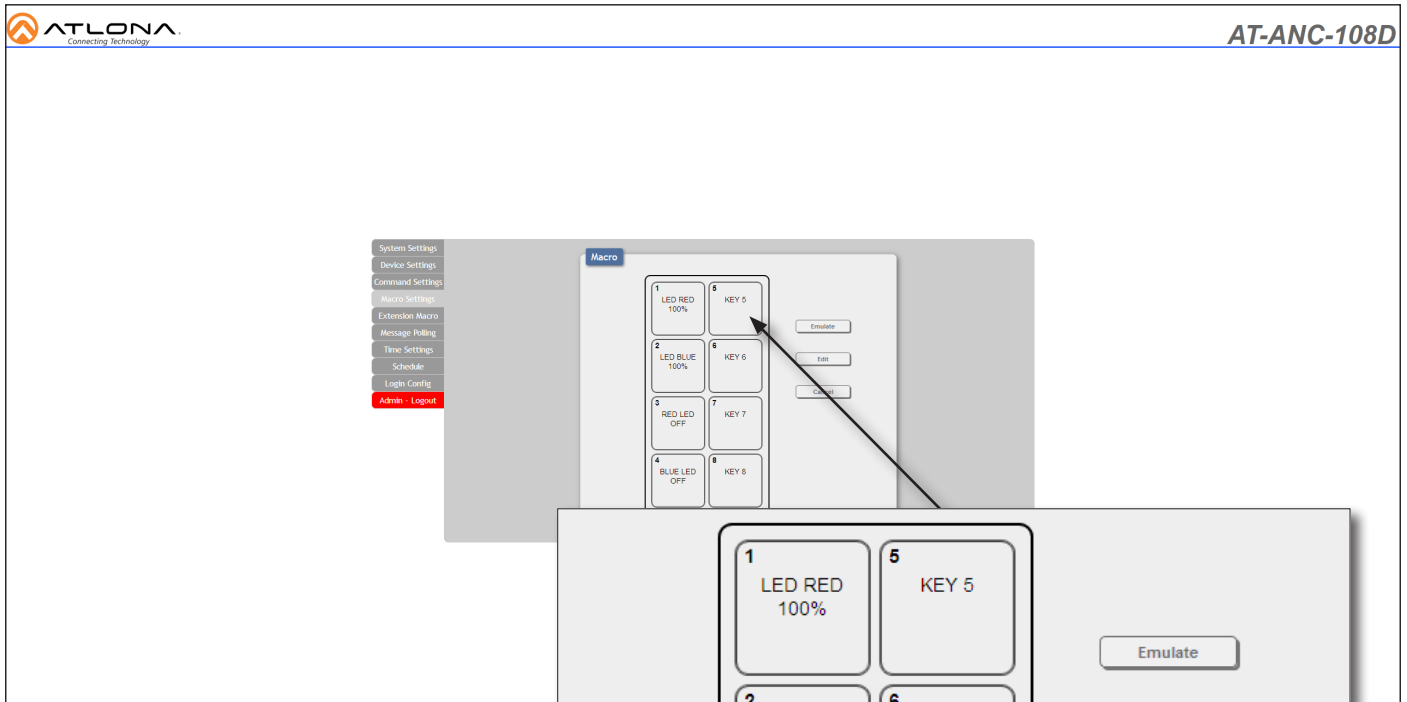

Emulate

Click this button to execute the macro assigned to the highlighted button.

Edit

Click this button to edit the macro settings.

Cancel

Deselects the highlighted button.

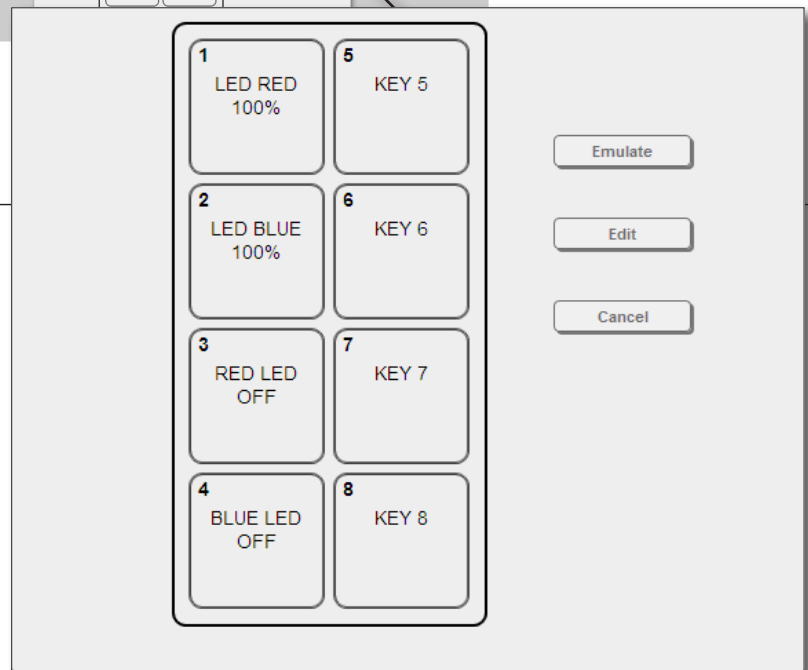

Configuration and Management Interfaces

Extension Macro tab

Extension Macros are required in order for the buttons on the AT-ANC-108D to display the current state of a device.

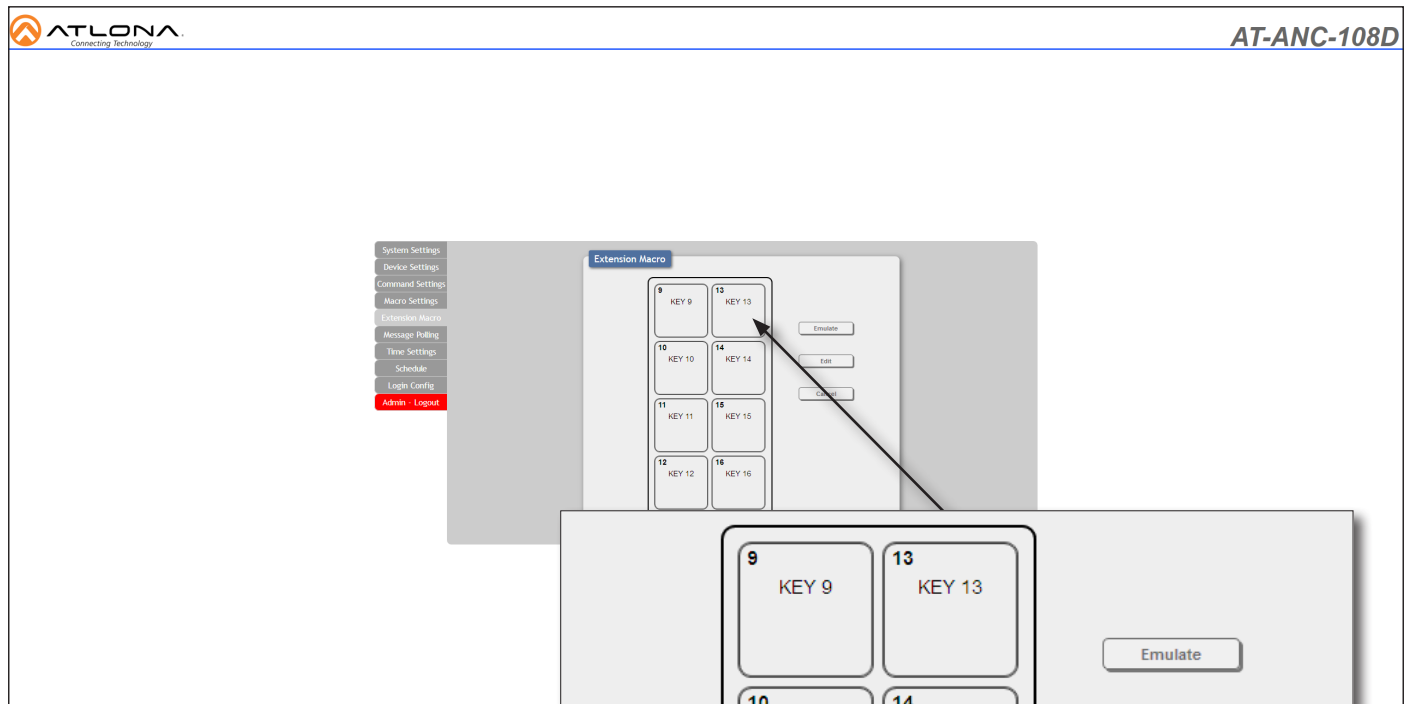

Emulate

Click this button to execute the extension macro assigned to the highlighted button.

Edit

Click this button to edit the extension macro settings.

Cancel

Deselects the highlighted button.

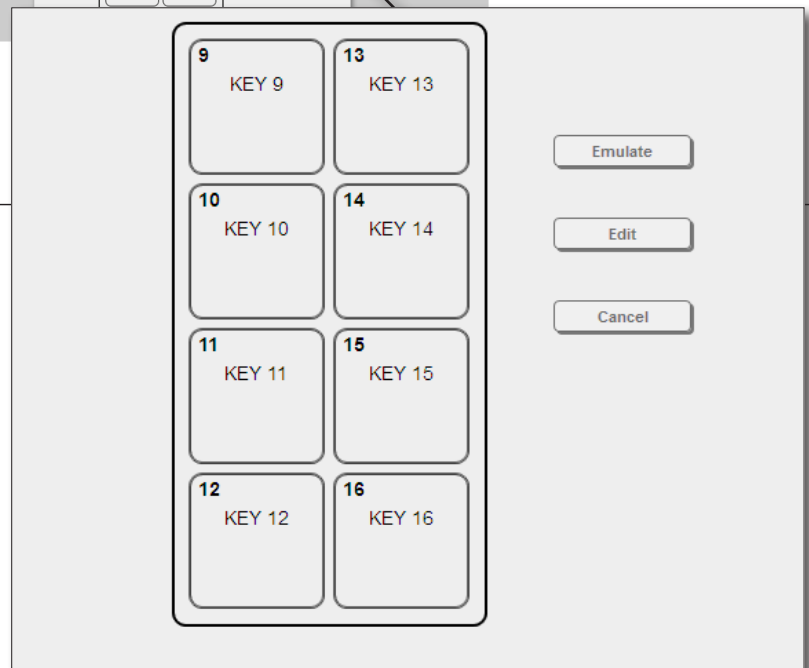

Configuration and Management Interfaces

Message Polling tab

This tab allows the AT-ANC-108D to send a command, which behaves as a status call, to each of the connected devices.

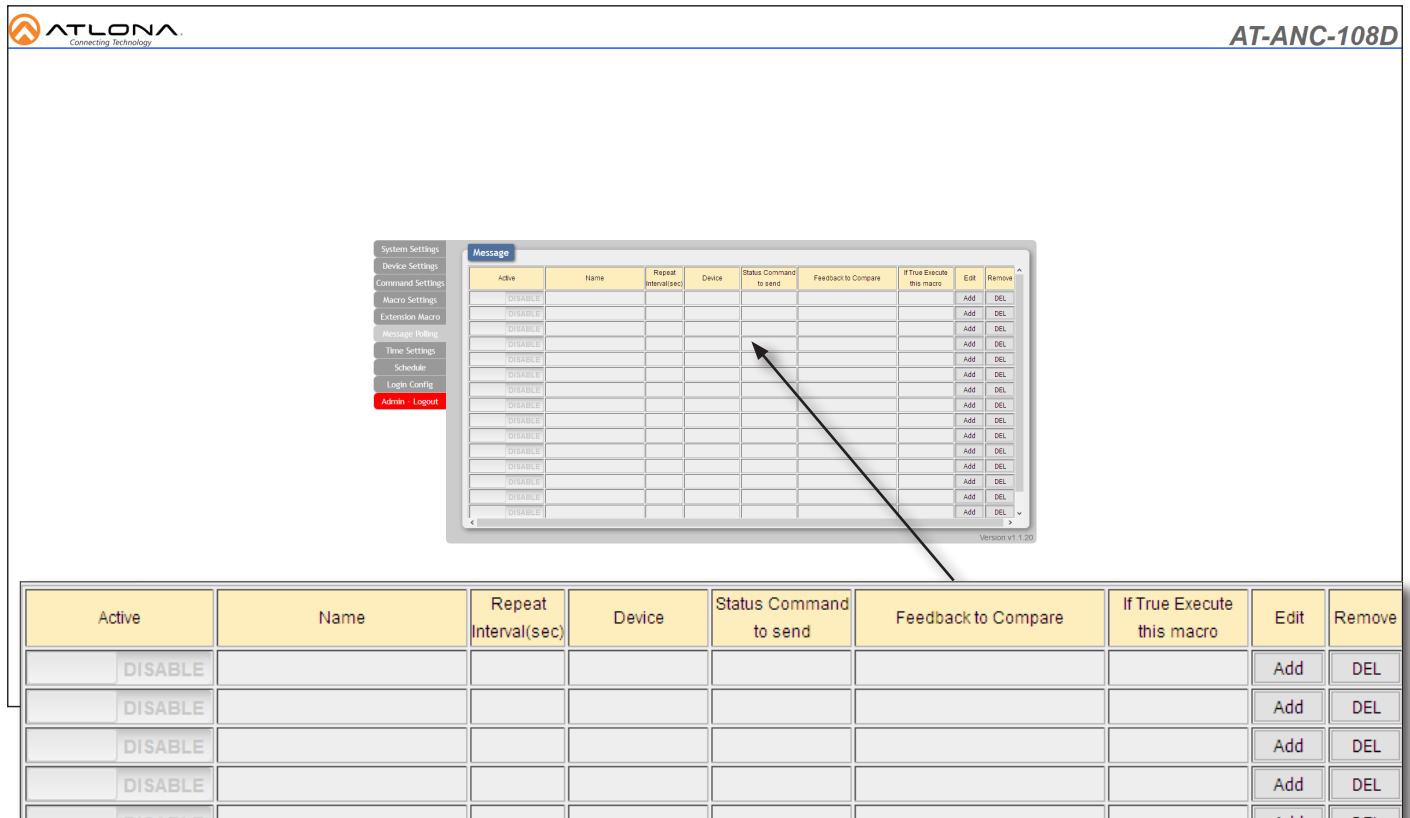

Active	Name	Repeat Interval(sec)	Device	Status Command to send	Feedback to Compare	If True Execute this macro	Edit	Remove
DISABLE							Add	DEL
DISABLE							Add	DEL
DISABLE							Add	DEL
DISABLE							Add	DEL
DISABLE							Add	DEL
DISABLE							Add	DEL
DISABLE							Add	DEL
DISABLE							Add	DEL
DISABLE							Add	DEL
DISABLE							Add	DEL
DISABLE							Add	DEL
DISABLE							Add	DEL
DISABLE							Add	DEL
DISABLE							Add	DEL
DISABLE							Add	DEL
DISABLE							Add	DEL
DISABLE							Add	DEL
DISABLE							Add	DEL
DISABLE							Add	DEL
DISABLE							Add	DEL
DISABLE							Add	DEL

Active

Click this toggle switch to ENABLE or DISABLE status polling for the device.

Name

Displays the descriptive name of the device.

Repeat Interval

Displays the repeat interval in seconds. For example, if this field displays “5”, then polling will occur every 5 seconds.

Device

The name of the physical device.

Status Command to send

Displays the name of the actual API call.

Feedback to Compare

Displays the device’s broadcast response. For example, on an AT-HD-SC-500, if the ‘Mute Status’ is sent to the device, then the device response would be either `VOUT-Mute1 on` or `VOUTMute1 off`.

If True Execute this macro

Displays the macro that will be executed, depending on the Feedback to Compare column. For example, if the **Feedback to Compare** value is `VOUTMute1 on`, then the `Mute On` macro is executed.

Edit

Click the **Add** button to add a new polling configuration. Click the Edit button (not shown) to modify an existing polling configuration. The **Add** button is only displayed on empty rows. Once a new polling configuration is added, the **Add** button for that row will change to an **Edit** button.

Remove

Click the **DEL** button to delete a polling configuration from the list.

Configuration and Management Interfaces

Time Settings tab

This tab provides the ability to set the internal clock on the AT-ANC-108D. Refer to [Setting the System Date and Time \(page 32\)](#) for more information.

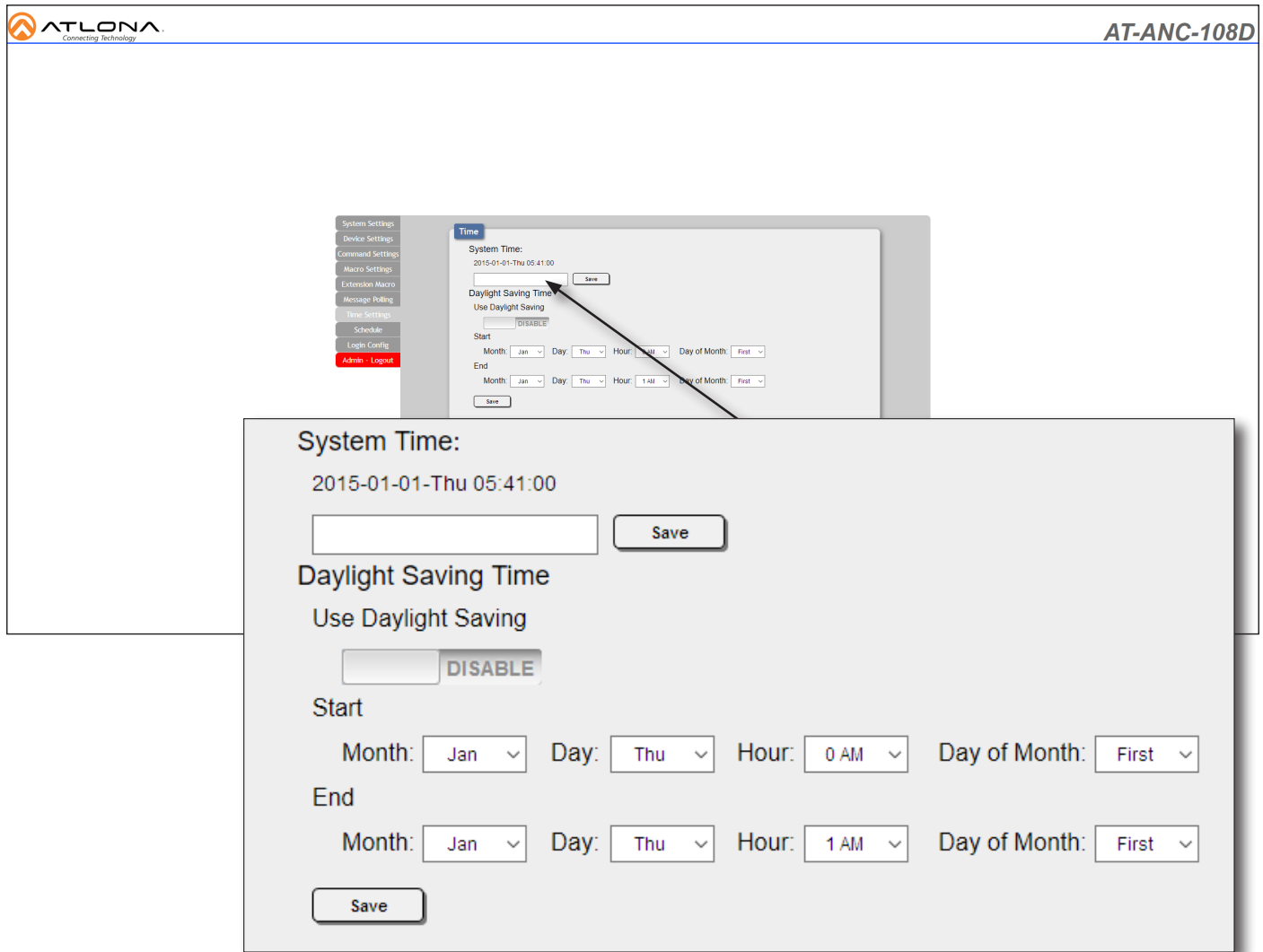

System Time

Click in this field to select the desired year, month, and date.

Save

Click this button to commit the changes in the **System Time** section.

Use Daylight Saving

Click this toggle switch to ENABLE or DISABLE Daylight Saving Time (DST).

Start

Click each of these drop-down lists to set the month, day, and hour when DST begins.

End

Click each of these drop-down lists to set the month, day, and hour when DST ends.

Save

Click this button to commit all changes under the Daylight Saving Time section.

Configuration and Management Interfaces

Schedule tab

This tab provides the ability to execute a repeating event or one-time event to a device. For example, it may be useful to execute a 'power off' macro for a device at 10:00 PM every evening.

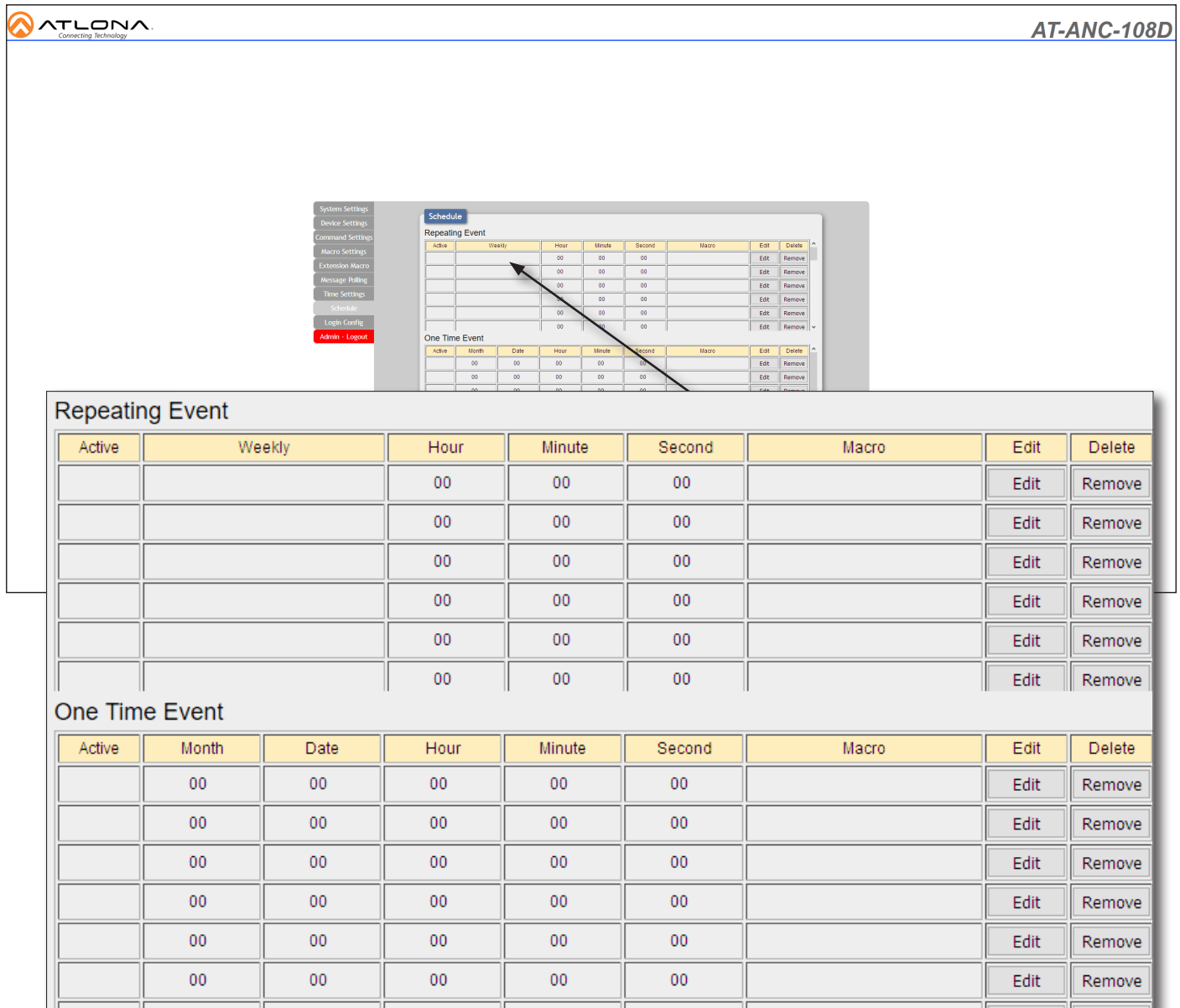

The screenshot shows the AT-ANC-108D interface with the 'Schedule' tab selected. The sidebar menu includes: System Settings, Device Settings, Command Settings, Macro Settings, Extension Macro, Message Polling, Time Settings, Schedule, Login Configs, and Admin - Logout. The main content area displays two tables:

Repeating Event								
Active	Weekly	Hour	Minute	Second	Macro	Edit	Delete	
		00	00	00		Edit	Remove	
		00	00	00		Edit	Remove	
		00	00	00		Edit	Remove	
		00	00	00		Edit	Remove	
		00	00	00		Edit	Remove	
		00	00	00		Edit	Remove	
		00	00	00		Edit	Remove	

One Time Event								
Active	Month	Date	Hour	Minute	Second	Macro	Edit	Delete
	00	00	00	00	00		Edit	Remove
	00	00	00	00	00		Edit	Remove
	00	00	00	00	00		Edit	Remove
	00	00	00	00	00		Edit	Remove
	00	00	00	00	00		Edit	Remove
	00	00	00	00	00		Edit	Remove
	00	00	00	00	00		Edit	Remove

Active

Displays whether or not the event is active.

Weekly

Displays the days of the week when the macro is executed.

Hour

Displays the hour at which the macro is executed. The hour is based on a 24-hour clock.

Minute

Displays the minute at which the macro is executed.

Macro

Displays the macro that is assigned to the event.

Second

Displays the second at which the macro is executed.

Edit

Click the **Edit** button to edit the event.

Delete

Click the **Remove** button to delete an event.

Configuration and Management Interfaces

Login Config tab

This tab allows the administrator password to be changed. Note that the username cannot be changed.

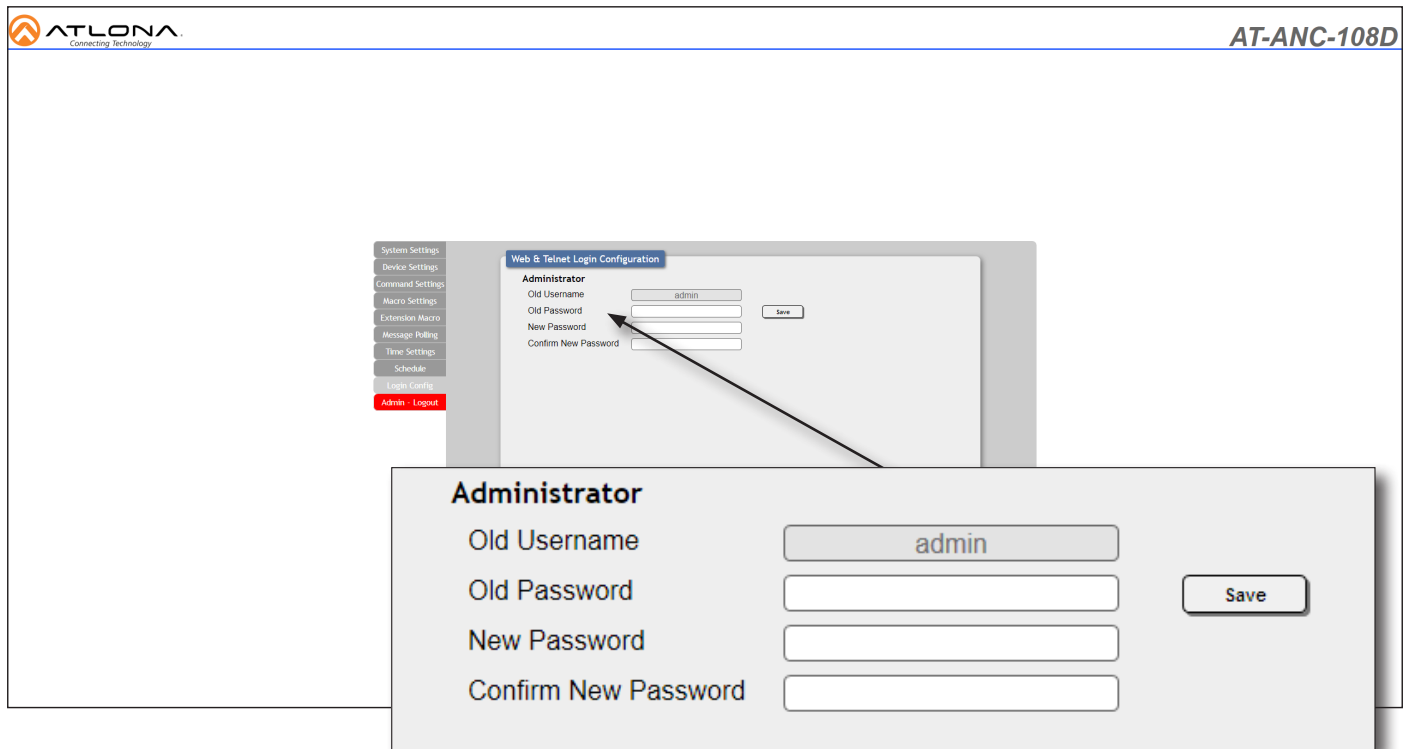

Old Username

The administrator username. This field cannot be changed.

Old Password

Enter the current password in this field.

New Password

Enter the new password in this field.

Confirm New Password

Enter the new password in this field, again, to confirm.

Save

Click this button to commit changes.

Device Operation

IP Configuration

The AT-ANC-108D is shipped with DHCP enabled. Once connected to a network, the DHCP server (if available), will automatically assign an IP address to the unit. The built-in web server is recommended to configure IP settings of the AT-ANC-180D. If a static IP address is desired, the unit can be switched to static IP mode. The default static IP address of the AT-ANC-108D is 192.168.1.50.

Resetting to Factory Defaults

Resetting the AT-ANC-108D requires that the wallplate be removed. Refer to [Wallplate Installation \(page 11\)](#) for more information. If no DHCP server is found after a factory-reset, then AT-ANC-108D will be assigned the default static IP address of 192.168.1.50. The subnet mask will be: 255.255.255.0 and the gateway will be 192.168.1.254.

1. Remove the wallplate from the AT-ANC-108D.
2. Press and hold the upper-right button.
3. Press the **Reset** button, using the end of a paper clip or other pointed object. The upper-right button will flash twice.
4. Release the upper-right button and the **Reset** button.
5. Reattach the wallplate to the AT-ANC-108D.

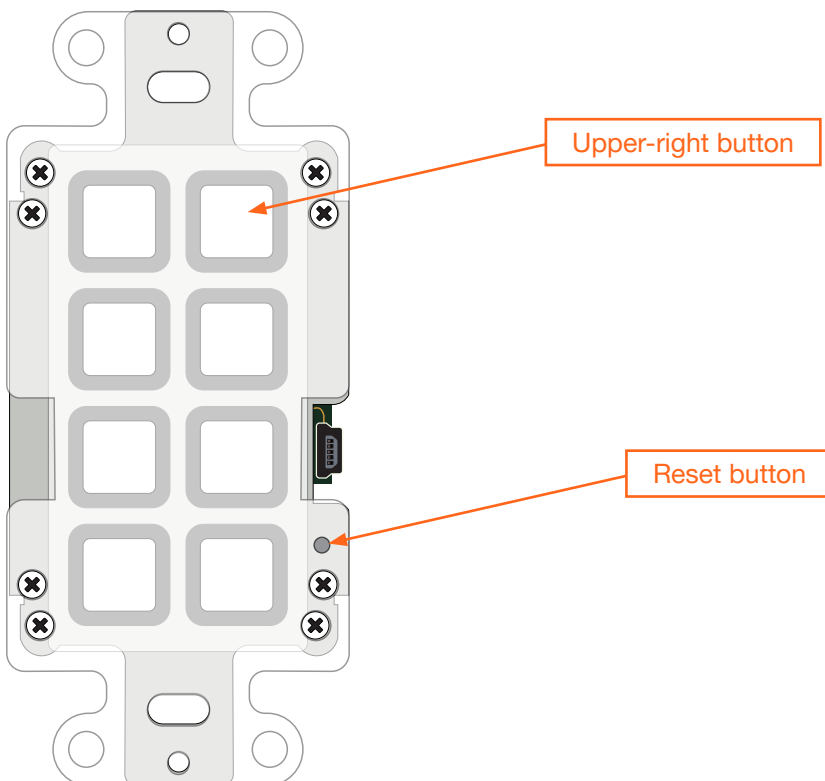

Accessing the Web Server

The AT-ANC-108D features a built-in web server, which allows the unit to be configured to control other Atlona products. By default, the AT-ANC-108D is set to DHCP mode and will automatically be assigned an IP address, if a DHCP server is present. To access the web server, the IP address of the AT-ANC-108D must be known. This can be accomplished by more than one method. Running IP scanner software or using the Address Resolution Protocol (ARP) are two possibilities. When running an IP scanner or using ARP, both the computer and the AT-ANC-108D must be connected to the same network.

Getting the IP Address

The following method uses the `arp` command, which is available from the command line in Windows. The `arp` command will display the IP-to-physical address translation tables used by the Address Resolution Protocol (ARP). The following procedure can be used for both encoders and decoders.

1. Identify the MAC address of the unit by locating the label on the side of the unit. *Figure 1.1* shows a sample label.

Figure 1.1 - Sample MAC address label found on the side of an AT-ANC-108D.



2. Connect a PC to the same network where the AT-ANC-108D is connected.
3. Type `cmd` in the search bar in Windows, then press [ENTER] to launch the command line interface.
4. At the command prompt, type `arp -a`. Make sure to include a space between `arp` and the `-a` argument, then press [ENTER].
5. Press [ENTER]. Several lines of information will be displayed. Locate the MAC address of the AT-ANC-108D under the **Physical Address** column. Directly across from the MAC address, the IP address of the encoder/decoder will be listed under the **Internet Address** column.

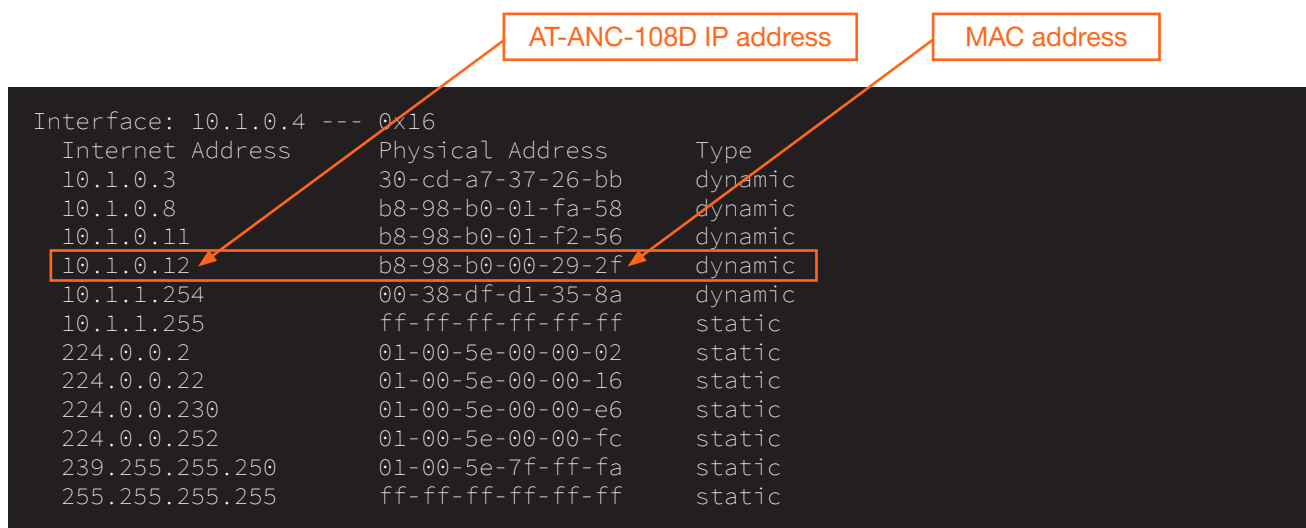

Logging In

1. Launch the desired web browser and enter the IP address of the encoder in the address bar.
2. Enter the username and password. Note that the password field will always be masked. The default credentials are:

Username: admin
Password: Atlona

3. Click the **Submit** button.

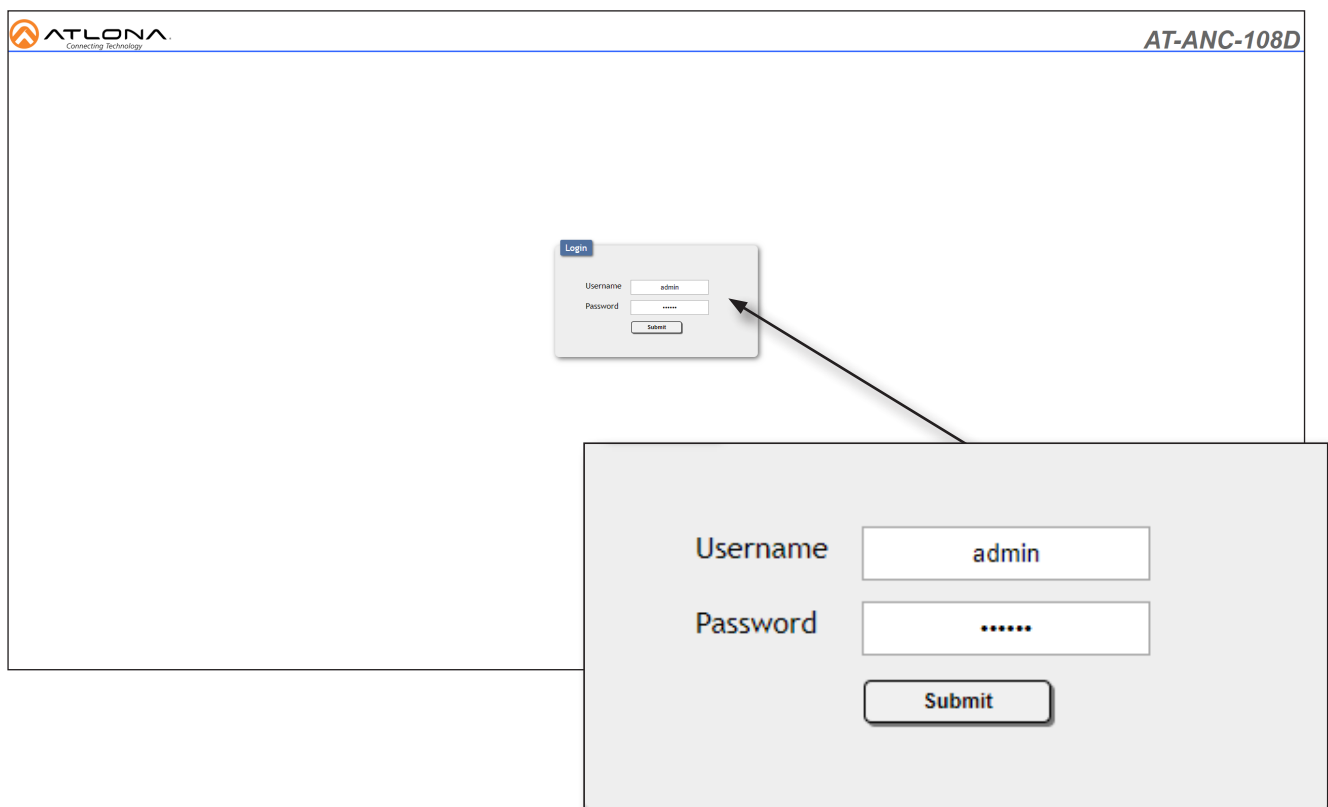

4. The **System Settings** page will be displayed. Refer to [System Settings tab \(page 12\)](#) for more information.
5. The login process is complete.

System Configuration

The AT-ANC-108D provides easy access to system configuration through the built-in web server, and is the recommended method to adjust network settings.

Changing the Network IP Mode

By default, the AT-ANC-108D is set to DHCP mode. Once connected to a network, and if a DHCP server is found (or available), the AT-ANC-108D will be assigned an IP address on the network, and no further network configuration is required. However, if the AT-ANC-108D is unable to detect a DHCP server within 15 seconds, then the unit will use the default static IP address of 192.168.1.50. The instructions below will focus on setting the AT-ANC-108D to static IP mode.



IMPORTANT: Before assigning a static IP address to the AT-ANC-108D, it is recommended to consult with the network or system administrator and obtain a available IP address. If the AT-ANC-108D is assigned an IP address which is already in use by another device, it may cause either network issues and/or the AT-ANC-108D will be not accessible.

1. Login to the web server. Refer to [Logging In \(page 24\)](#) for more information.
2. Click the **System Settings** tab.
3. Locate the **IP Mode** toggle switch. The default setting of this toggle switch is **DHCP**.
4. Click this toggle switch to set it to **STATIC IP**.

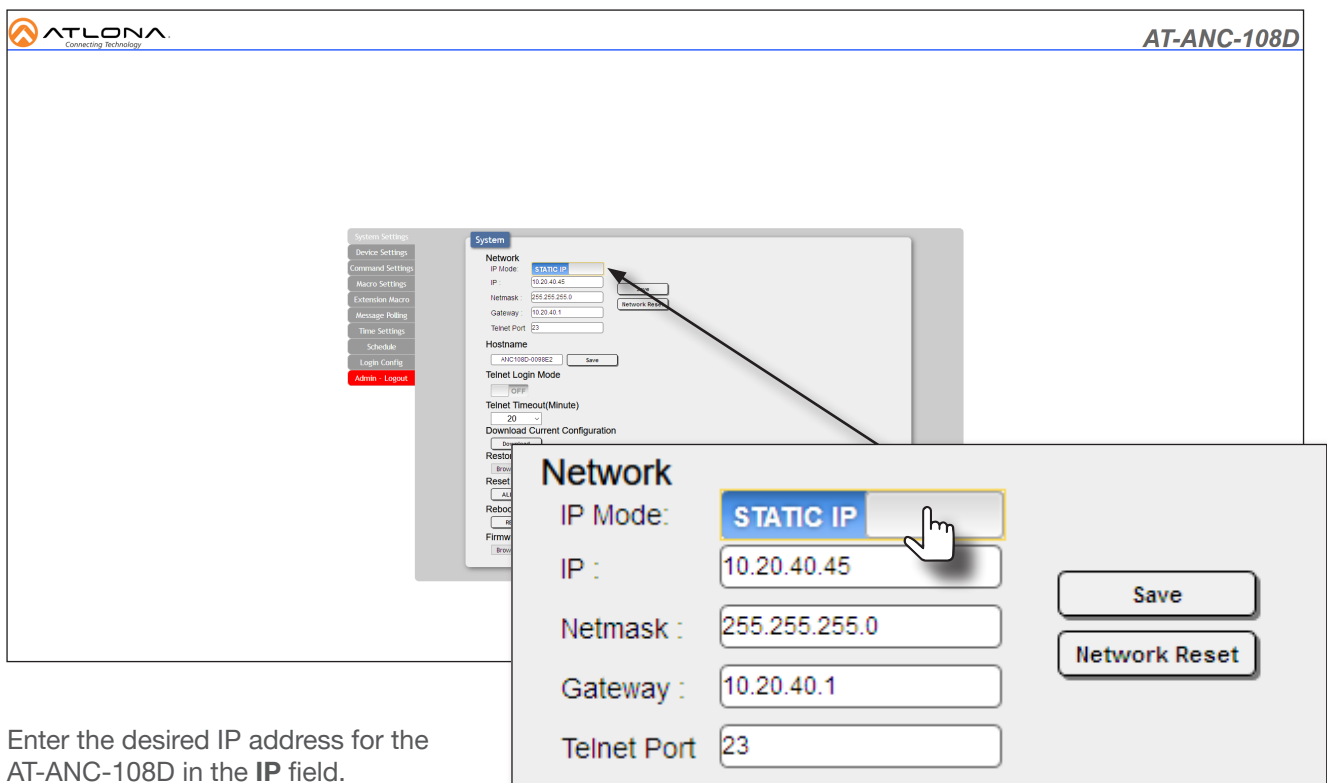

The screenshot shows the AT-ANC-108D web interface. The top left corner has the ATLONA logo and 'Connecting Technology'. The top right corner says 'AT-ANC-108D'. The main content area shows a 'System' configuration page with a sidebar on the left containing various settings tabs like 'System Settings', 'Device Settings', 'Command Settings', etc. The 'System' tab is active, and the 'Network' section is expanded. The 'IP Mode' is set to 'STATIC IP' (highlighted in blue). Below it, the 'IP' field contains '10.20.40.45', 'Netmask' is '255.255.255.0', 'Gateway' is '10.20.40.1', and 'Telnet Port' is '23'. A hand cursor is pointing to the 'STATIC IP' toggle. To the right of the fields are 'Save' and 'Network Reset' buttons.

5. Enter the desired IP address for the AT-ANC-108D in the **IP** field.
6. Enter the subnet mask and gateway address in the **Netmask** and **Gateway** fields, respectively.
7. Click the **Save** button to commit changes. Changes will take effect immediately.

Changing the Telnet Port

Typically, the Telnet service is assigned to TCP port 23. This is the default setting for the AT-ANC-108D. However, depending upon the network environment, the default Telnet port can be changed.

1. Login to the web server. Refer to [Logging In \(page 24\)](#) for more information.
2. Click the **System Settings** tab.
3. Locate the **Telnet Port** field and enter the desired port in the field.
4. Click **Save** to commit changes.

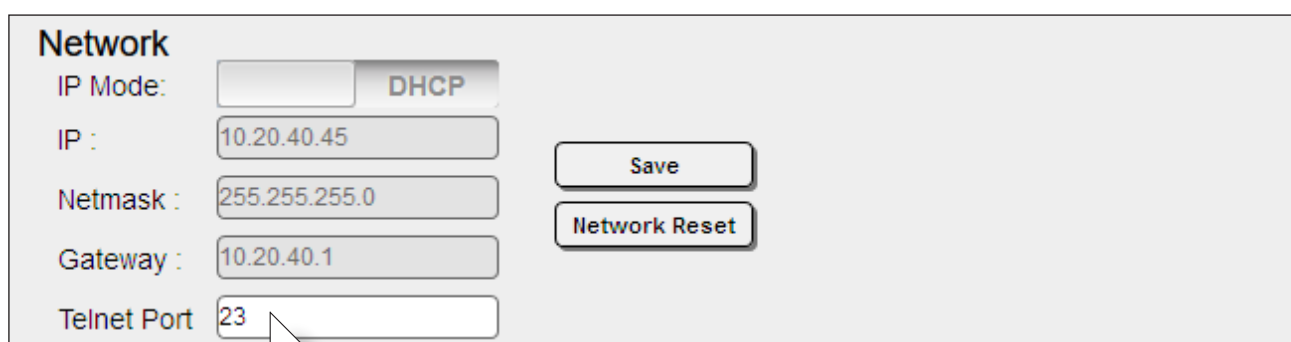

Network

IP Mode: DHCP

IP :

Netmask :

Gateway :

Telnet Port

Setting the Host Name

By default, the AT-ANC-108D is assigned a hostname, which is constructed as follows:

ANC108D-[last six digits of MAC address]

For example, a default hostname might look like this: ANC108D-00021B. This value can be changed to easily identify the AT-ANC-108D on the network. If using a custom hostname, it must meet the hostname standards, defined here: <https://tools.ietf.org/html/rfc1123>

1. Login to the web server. Refer to [Logging In \(page 24\)](#) for more information.
2. Click the **System Settings** tab.
3. Click the **Hostname** field and enter the desired name.
4. Click **Save** to commit changes.



Hostname

Telnet Login Mode

When a Telnet session is request, the AT-ANC-108D provides the option to prompt for user credentials or bypass authentication before the Telnet session begins. This credentials prompt option can enabled or disabled. When prompting for user credentials, use the same login information required by the built-in web server. By default, this setting is set to **OFF** (disabled).

1. Login to the web server. Refer to [Logging In \(page 24\)](#) for more information.
2. Click the **System Settings** tab.
3. Click the **Telnet Login Mode** toggle switch. Changes take effect immediately.
 - Set this toggle switch to **ON** to prompt for user credentials.
 - Set this toggle switch to **OFF** to bypass user credentials request.

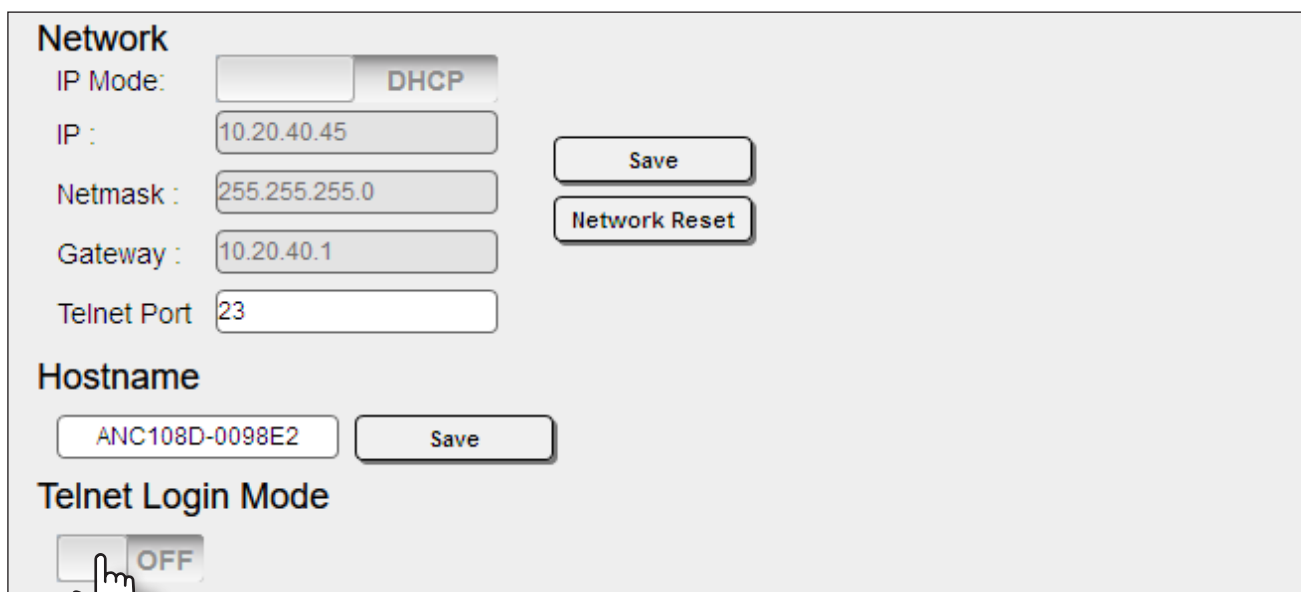

The screenshot shows the configuration page for the AT-ANC-108D. It is divided into three sections:

- Network:** Includes fields for IP Mode (set to DHCP), IP (10.20.40.45), Netmask (255.255.255.0), Gateway (10.20.40.1), and Telnet Port (23). There are 'Save' and 'Network Reset' buttons.
- Hostname:** Includes a text field with 'ANC108D-0098E2' and a 'Save' button.
- Telnet Login Mode:** Features a toggle switch currently set to 'OFF', with a hand cursor pointing to it.

Adjusting Telnet Timeout

When a Telnet session is active, the AT-ANC-108D can be set to monitor Telnet activity. If there is no activity within the specified time interval, the Telnet session will automatically be terminated, adding a measure of security. The Telnet time out interval also affects the web server time out interval. For example, if the Telnet time out interval is set to 1 minute, then the web server will automatically perform a log out operation after 1 minute.

1. Login to the web server. Refer to [Logging In \(page 24\)](#) for more information.
2. Click the **System Settings** tab.
3. Click the **Telnet Timeout** drop-down list and select the desired time-out interval. Values from 1 to 1000 minutes can be selected. Changes take effect immediately, once the time interval is selected.



The screenshot shows the 'Telnet Timeout(Minute)' configuration field. It is a drop-down menu with the value '20' selected. A hand cursor is pointing to the drop-down arrow.

Downloading System Configuration

The AT-ANC-108D allows the current system configuration to be downloaded to the connected computer, in .xml format. Multiple configurations can be saved and then restored at any time. Refer to [Restoring System Configuration \(page 29\)](#) for more information.

1. Login to the web server. Refer to [Logging In \(page 24\)](#) for more information.
2. Click the **System Settings** tab.
3. Click the **Download** button.

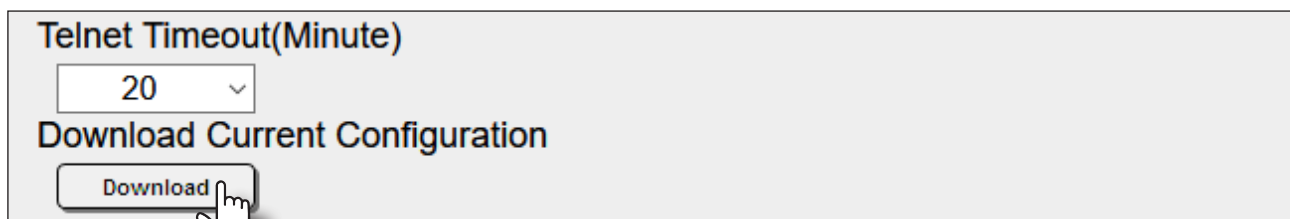

4. The page will display a “Wait...” message and after a few moments, the **XML Edit** dialog box will be displayed.

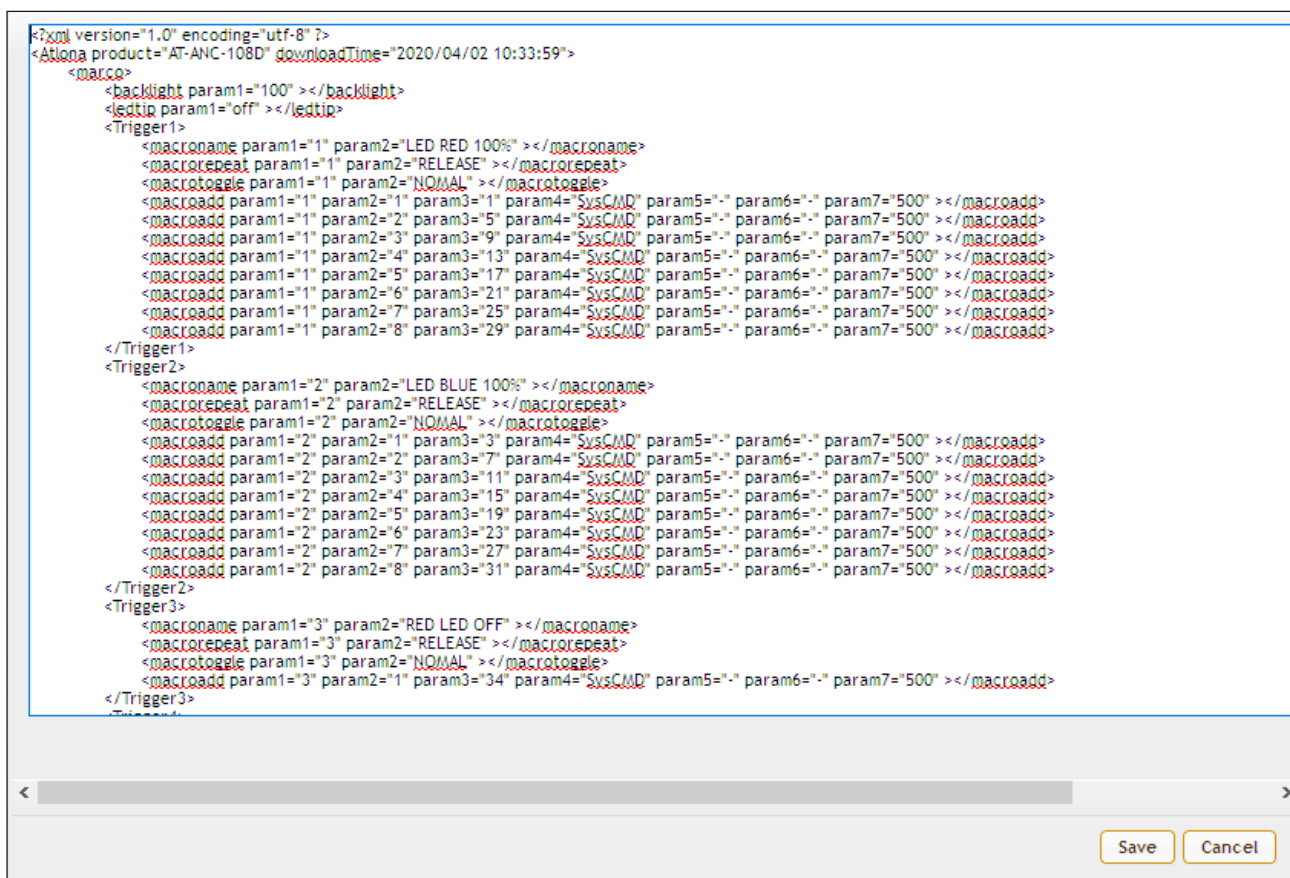

5. Click the **Save** button to save the file to the computer or click **Cancel** to abort the operation. When saved, the default filename name will be AT-ANC-108D.xml.

Restoring System Configuration

Once a system configuration has been saved as an .xml file, this file can be uploaded to the AT-ANC-108D, allowing a system configuration to be restored. Both the **Download** and **Restore** feature are useful for saving and loading different configurations and/or to provide a backup, in the unlikely event of a system failure. When a system configuration file is uploaded, it will overwrite the current settings.



IMPORTANT: IP Mode information is stored as part of the configuration file. Therefore, caution should be exercised when sharing configuration files between multiple AT-ANC-108D units. If the unit is set to *static* IP mode, then restoring multiple units with the same configuration file will result in the same IP address being shared between multiple units, causing an IP conflict on the network. *However, pre-configured device files, which are available from the Atlona web site, will not erase current network settings on the AT-ANC-108D.*

1. Login to the web server. Refer to [Logging In \(page 24\)](#) for more information.
2. Click the **System Settings** tab.
3. Click the **Browse...** button and select the desired system configuration file. Once the file is selected, the selected filename will appear next to the **Browse...** button.
4. Click the **Restore** button to upload the configuration file to the AT-ANC-108D.

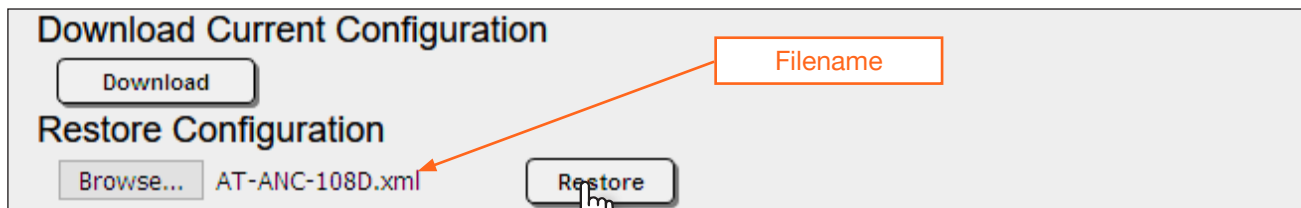

5. The following message box will be displayed, confirming overwrite of the current configuration. Click **OK** to continue with process or click **Cancel** to abort.

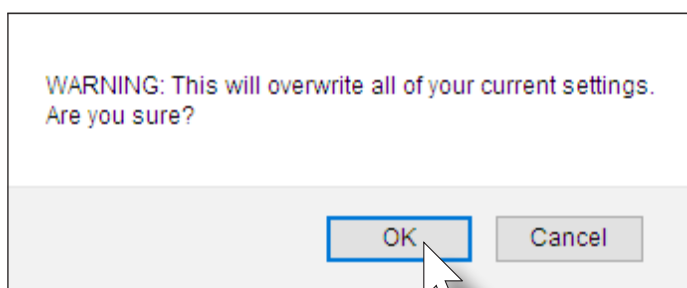

6. Once the upload has started, a progress message will be displaying the restore process.
7. Once restore process has completed, the message "XML Restore Finish! Please Refresh Page!" will be displayed. Refresh the page.
8. The **Login** page will be displayed.
9. The restoration process is complete.

Resetting to Factory-Default Settings

The following procedure will reset the AT-ANC-108D to factory-default settings. The network IP mode will be set to DHCP mode.

1. Login to the web server. Refer to [Logging In \(page 24\)](#) for more information.
2. Click the **System Settings** tab.
3. Click the **ALL Reset** button.

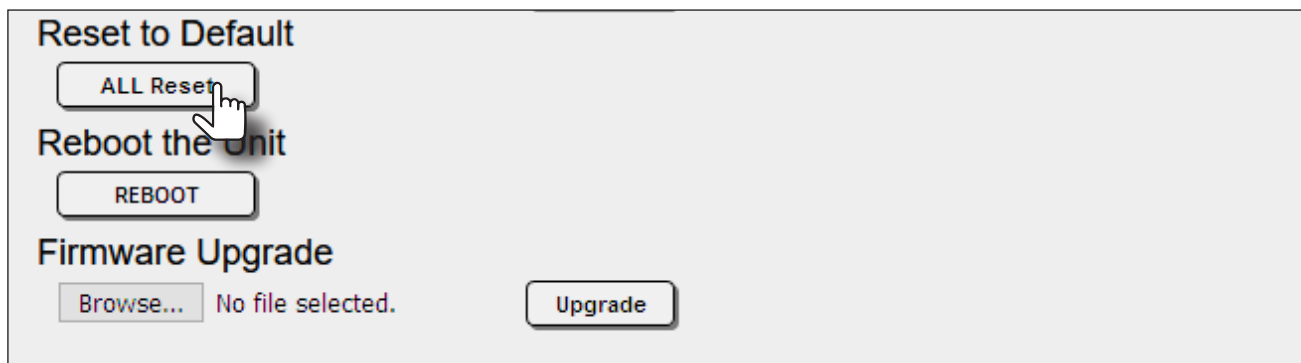

4. The following message box will be displayed, confirming the reset operation. Click **OK** to continue with process or click **Cancel** to abort.

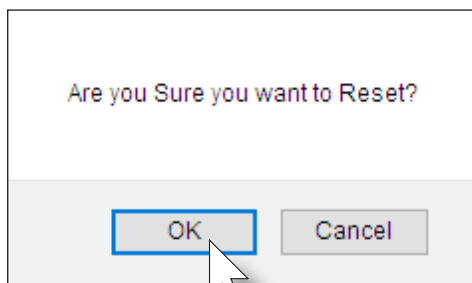

5. The “Wait...” message will be displayed. After a few moments, the web page may indicate a “lost connection”. If this happens, refresh the page or enter the IP address of the unit in the address bar.
6. The **Login** screen will be displayed.
7. The reset process is complete.

Rebooting the AT-ANC-108D

The following procedure will perform a soft reboot of the AT-ANC-108D. All unit settings are preserved.

1. Login to the web server. Refer to [Logging In \(page 24\)](#) for more information.
2. Click the **System Settings** tab.
3. Click the **REBOOT** button.

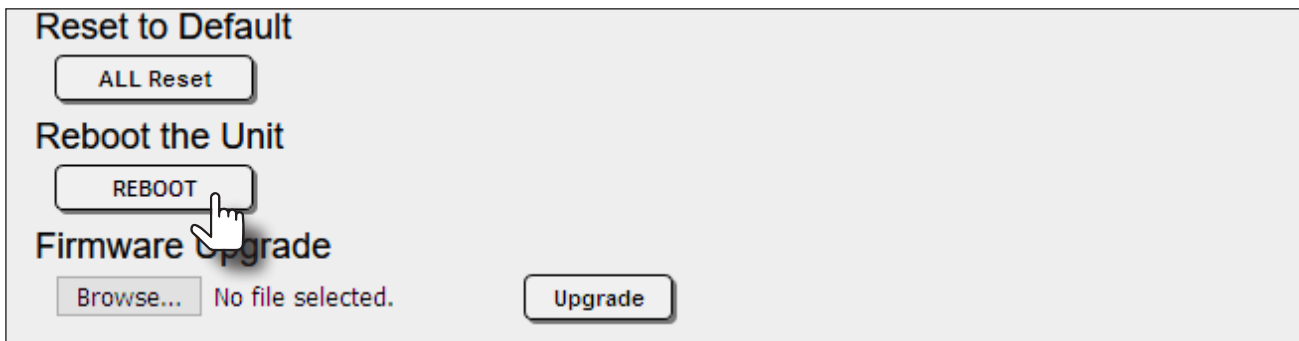

4. The following message box will be displayed, confirming the reboot operation. Click **OK** to continue with process or click **Cancel** to abort.

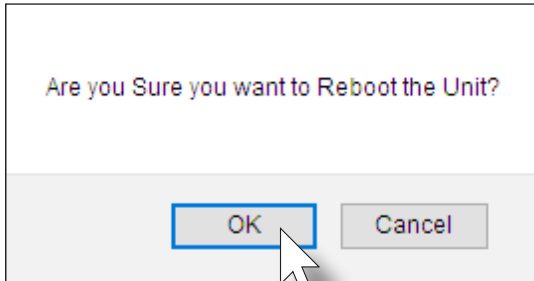

5. The "Wait..." message will be displayed. After about 15 seconds, the web page may indicate a "lost connection". If this happens, refresh the page or enter the IP address of the unit in the address bar.
6. The **Login** screen will be displayed.
7. The reboot process is complete.

Setting the System Date and Time

The AT-ANC-108D uses the internal clock to store the current date and time. When setting the time and date, the 24-hour clock format is used.

Setting Local Time

1. Login to the web server. Refer to [Logging In \(page 24\)](#) for more information.
2. Click the **Time Settings** tab.
3. Click in the field under the **System Time** section.

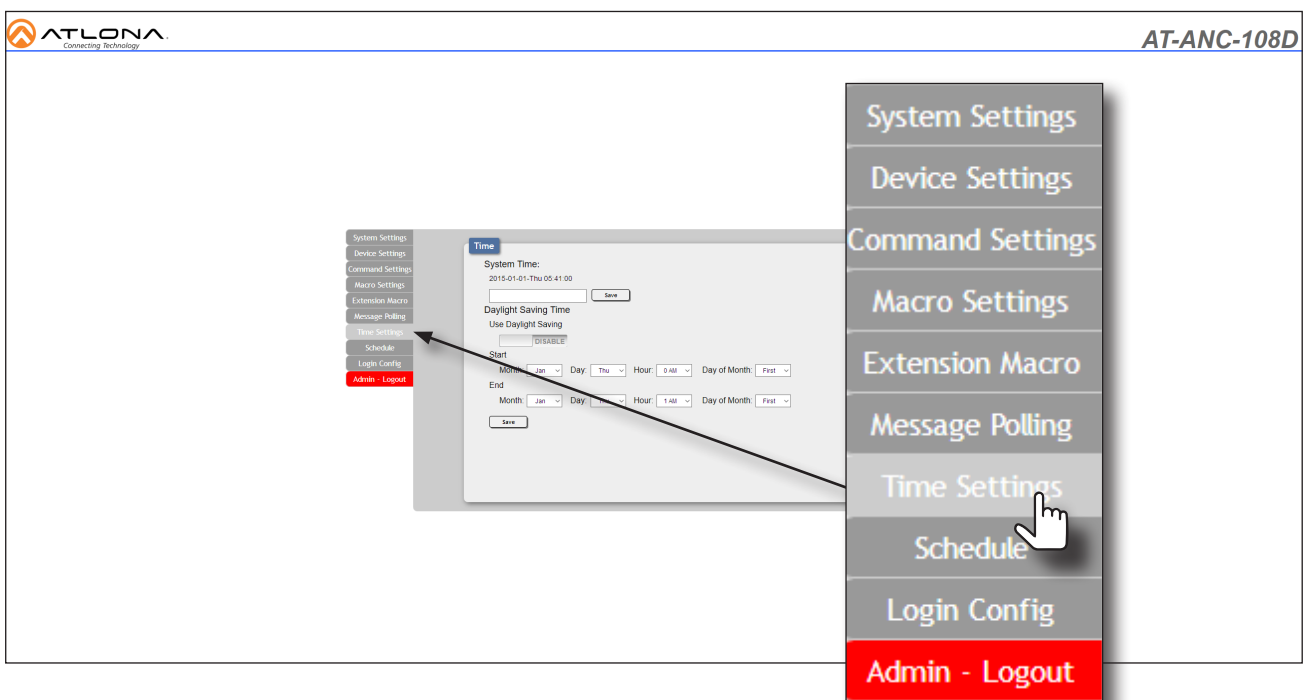

4. The time pop-up dialog will be displayed, shown below.

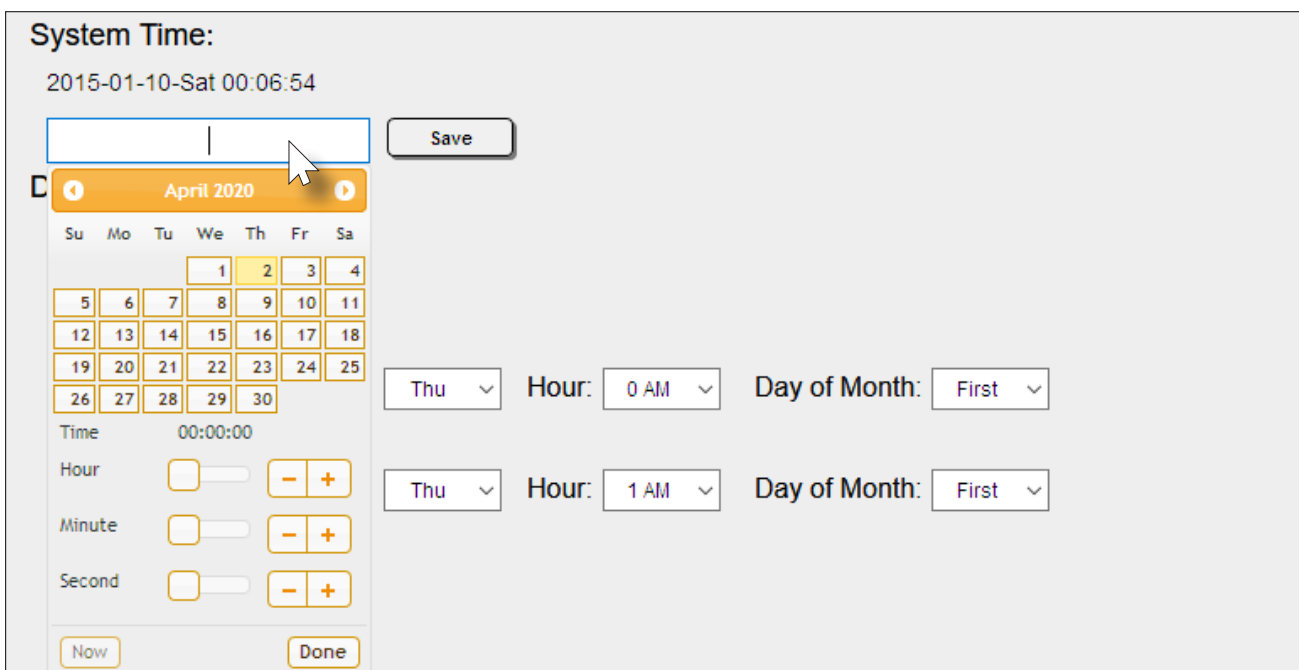

Device Operation

5. Click the desired date in the calendar section. To advance to the next month, click the ► icon. To go back to the previous month, click the ◀ icon.
6. Click and drag the **Hour** slider, or use the + or - buttons to set the hour.
7. Repeat step 6 for both the **Minute** and **Second**. The **Now** button may also be clicked to set the local time used by the computer.
8. Click the **Done** button to commit changes.

System Time:
2015-01-10-Sat 00:27:04

2020-04-02-Thu 14:27:55

◀ April 2020 ▶

Su	Mo	Tu	We	Th	Fr	Sa
			1	2	3	4
5	6	7	8	9	10	11
12	13	14	15	16	17	18
19	20	21	22	23	24	25
26	27	28	29	30		

Time 14:27:55

Hour Hour: Day of Month:

Minute Hour: Day of Month:

Second

Setting Daylight Savings Time (DST)

The AT-ANC-108D provides the option to adjust the internal clock to compensate for Daylight Saving Time, depending on the region. Daylight Saving Time is disabled, by default.

1. Login to the web server. Refer to [Logging In \(page 24\)](#) for more information.
2. Click the **Time Settings** tab.
3. Set the **Use Daylight Saving** toggle switch to **ENABLE**.

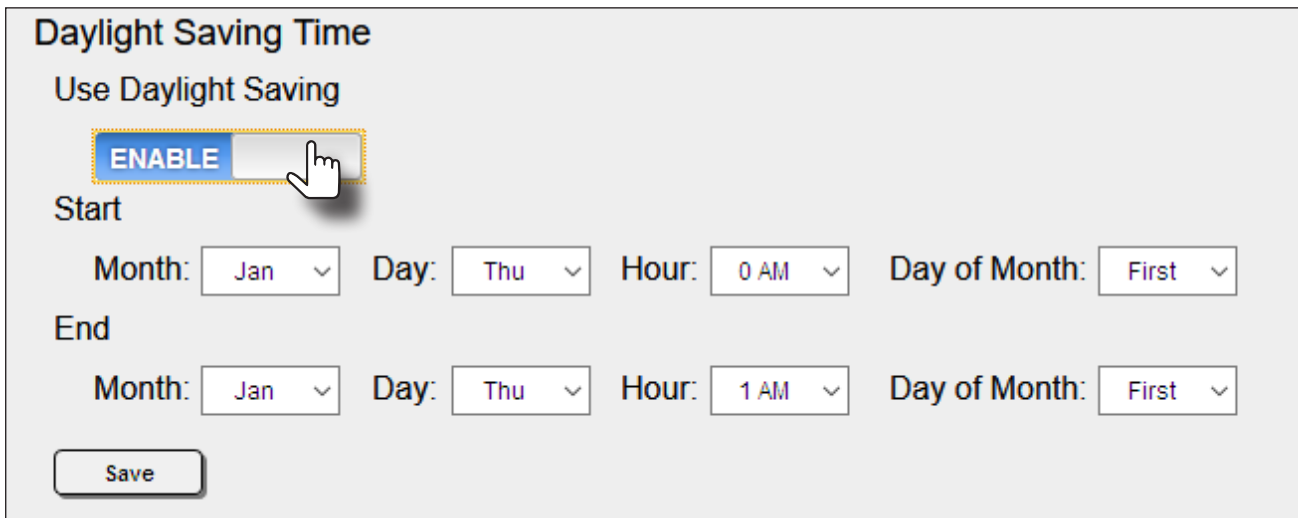

Daylight Saving Time

Use Daylight Saving

ENABLE

Start

Month: Day: Hour: Day of Month:

End

Month: Day: Hour: Day of Month:

4. Click the **Start** drop-down lists for **Month**, **Day**, **Hour**, and **Day of Month**, and set the desired values.
5. Repeat this process for the **End** drop-down lists.
6. Click the **Save** button to commit changes.

Password Management

The AT-ANC-108D allows the administrator password to be changed. The password applies to both the web server and Telnet sessions. Note that the Username field cannot be changed.

1. Login to the web server. Refer to [Logging In \(page 24\)](#) for more information.
2. Click the **Login Config** tab.
3. Click the **Old Password** field and enter the current password.

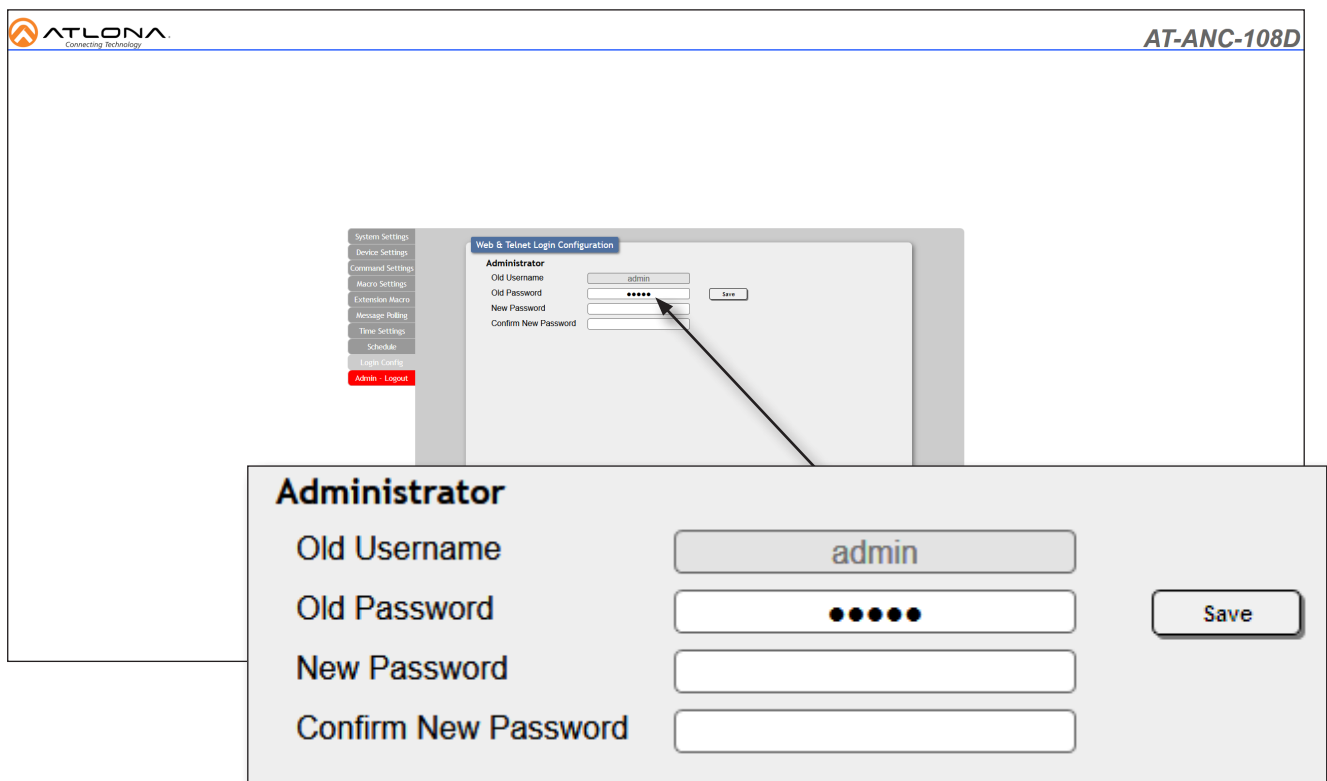

The screenshot shows the AT-ANC-108D web interface. The top left corner has the ATLONA logo and 'Connecting Technology'. The top right corner says 'AT-ANC-108D'. A sidebar on the left contains navigation tabs: System Settings, Device Settings, Command Settings, Macro Settings, Extension Macro, Message Policy, Time Settings, Schedule, Login Config, and Admin - Logout. The main content area is titled 'Web & Telnet Login Configuration'. Under the 'Administrator' section, there are four input fields: 'Old Username' (containing 'admin'), 'Old Password' (masked with dots), 'New Password', and 'Confirm New Password'. A 'Save' button is located to the right of the 'Old Password' field. An arrow points from the 'Old Password' field in the screenshot to a larger, detailed view of the same form below.

Administrator

Old Username

Old Password

New Password

Confirm New Password

4. Enter the new password in the **New Password** field.
5. Retype the new password in the **Confirm New Password** field.
6. Click the **Save** button to commit changes. To login with the new username, click the **Admin - Logout** tab, then enter the new password on the **Login** page.

i **NOTE:** Password fields will always be masked for security purposes.

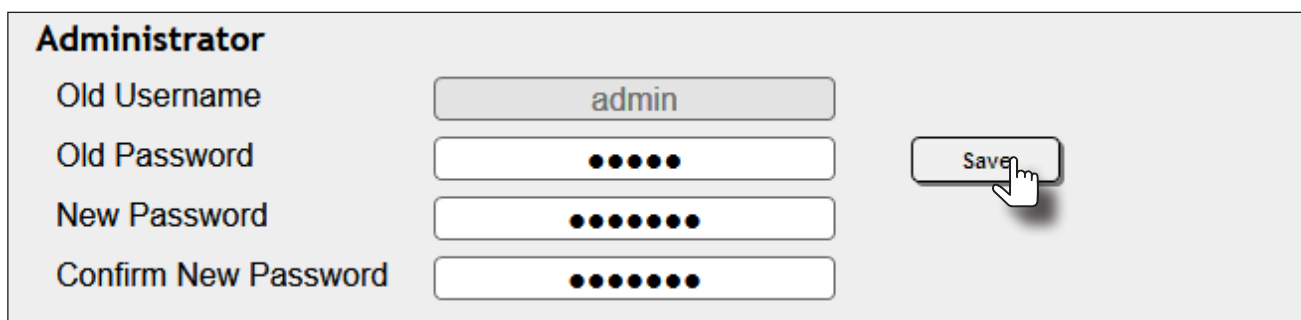

Administrator

Old Username

Old Password

New Password

Confirm New Password

Device Configuration

Each button on the AT-ANC-108D can be assigned to control a different function on another Atлона product. In addition, device configuration preset files can be downloaded from the AT-ANC-108D product page.

Button Orientation

Before selecting the device to be mapped, make sure the AT-ANC-108D is in the proper orientation: Button 1 is in the upper-left corner of the unit; Button 8 will be in the lower-right corner of the unit, as shown below. The mini-USB port should be on the right side of the unit, as it faces forward.

The button numbering, as displayed in the **Macro Settings** tab of the web server, matches the numbering scheme of each button on the AT-ANC-108D. The first column of buttons is numbered 1 through 4, and the second column of buttons is numbered 5 through 8.

AT-ANC-108D (front view)

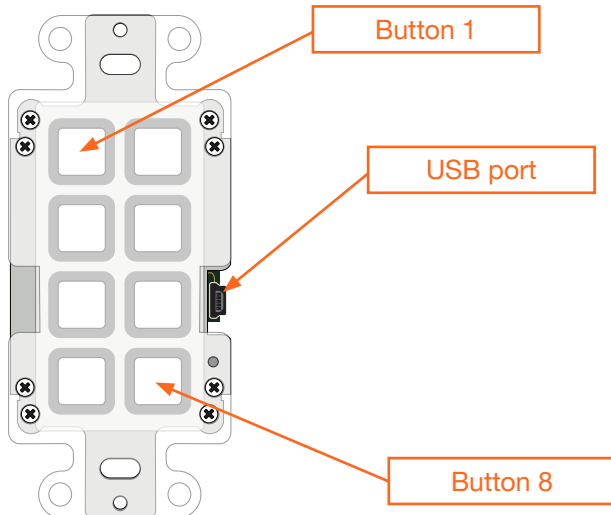

Macro Screen

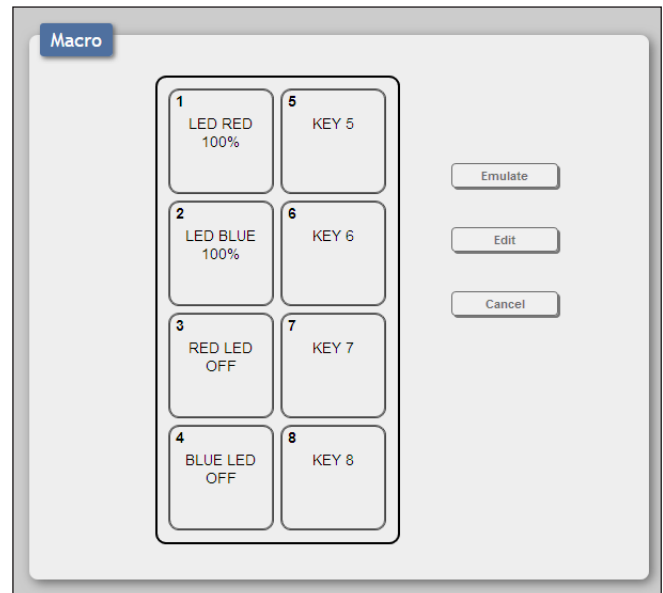

Adding a Device

1. Login to the web server. Refer to [Logging In \(page 24\)](#) for more information.
2. Click the **Device Settings** tab.
3. Click the **Add** button.

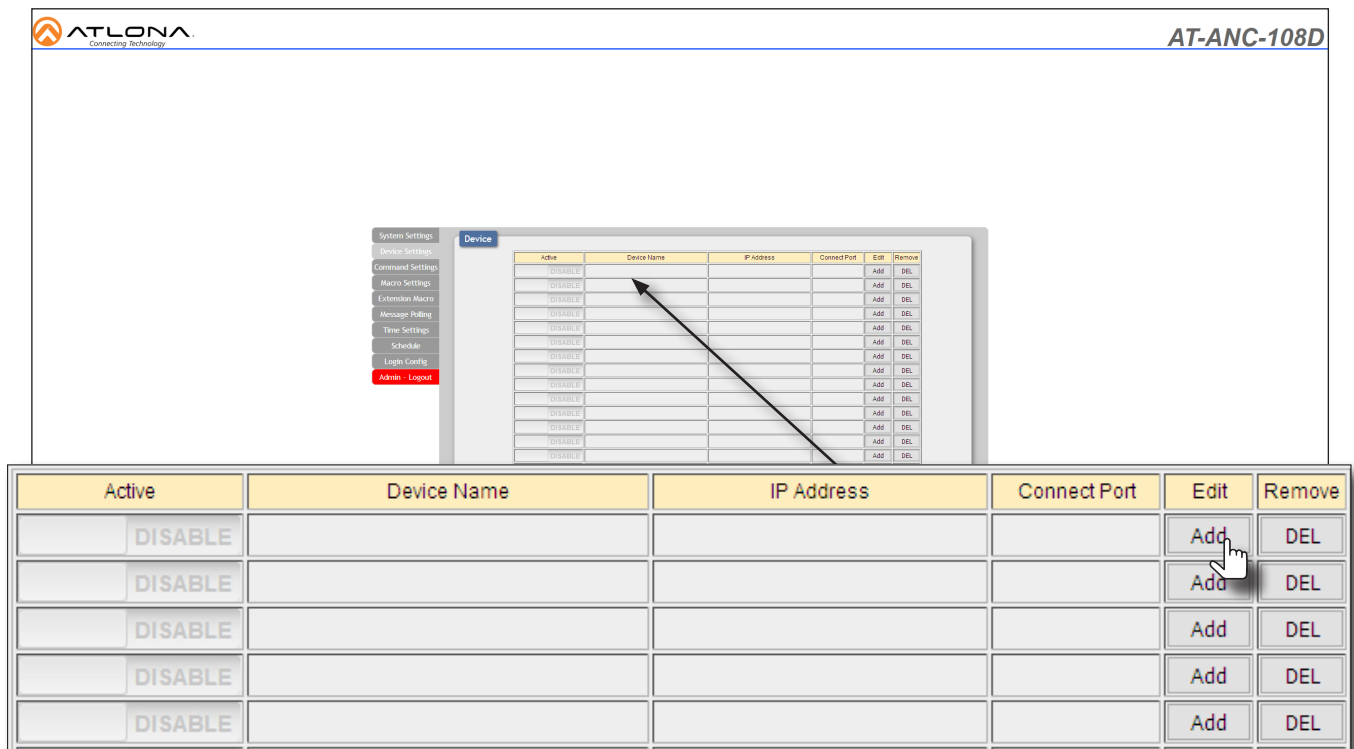

Active	Device Name	IP Address	Connect Port	Edit	Remove
DISABLE				Add	DEL
DISABLE				Add	DEL
DISABLE				Add	DEL
DISABLE				Add	DEL
DISABLE				Add	DEL

4. The **Device Edit** dialog will be displayed. Enter the required information in the **Device Name**, **IP Address**, and **Connect Port** fields. In the following example, the AT-OME-ST31A is being used. Note that the **Device Name** field can be any string and does not have to be the SKU. The **Connect Port** field is the port used for Telnet sessions.
5. Click the **Save Changes** button to commit changes.

Device 1 Edit
✕

Device Name

IP Address

Connect Port

6. The device is now added and the **Active** toggle switch is automatically set to **ENABLE**.

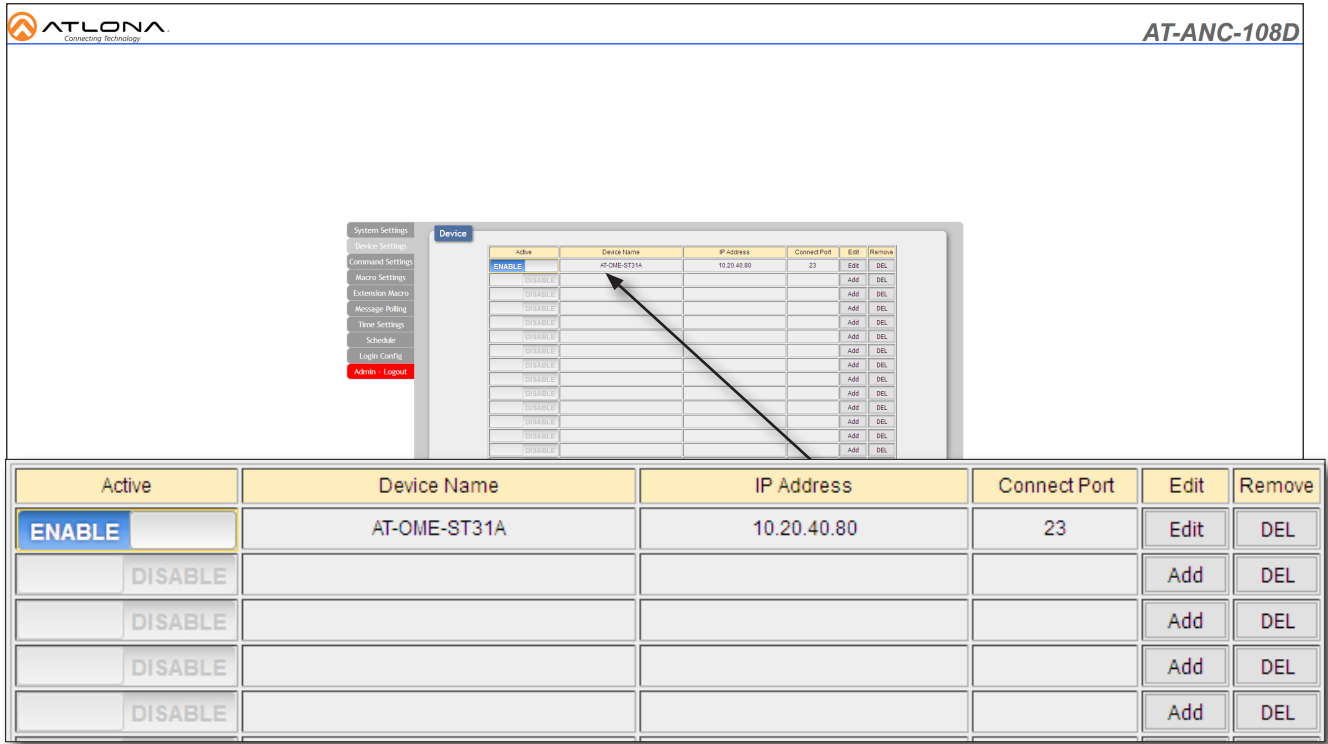

The screenshot shows the AT-ANC-108D web interface. A 'Device' table is visible with the following data:

Active	Device Name	IP Address	Connect Port	Edit	Remove
ENABLE	AT-OME-ST31A	10.20.40.80	23	Edit	DEL
DISABLE				Add	DEL
DISABLE				Add	DEL
DISABLE				Add	DEL
DISABLE				Add	DEL
DISABLE				Add	DEL
DISABLE				Add	DEL
DISABLE				Add	DEL
DISABLE				Add	DEL
DISABLE				Add	DEL
DISABLE				Add	DEL
DISABLE				Add	DEL
DISABLE				Add	DEL
DISABLE				Add	DEL
DISABLE				Add	DEL

The 'Active' column shows a toggle switch for each row. The first row's toggle is in the 'ENABLE' position, while all others are in the 'DISABLE' position. An arrow points to the 'ENABLE' toggle in the first row.

Command Configuration

1. Click the **Command Settings** tab. This tab is where the commands for each function are entered. Atlona devices are controlled using Telnet. However, any TCP or UDP device may be controlled as well.
2. Scroll down past the “LED Red” and “LED Blue” command names, to a blank row.



NOTE: LED command names are presets, and do not require modification, unless a specific type of feedback is required. This is rare. LED “on” states are 100% and “off” states are set to 0%, by default.

AT-ANC-108D

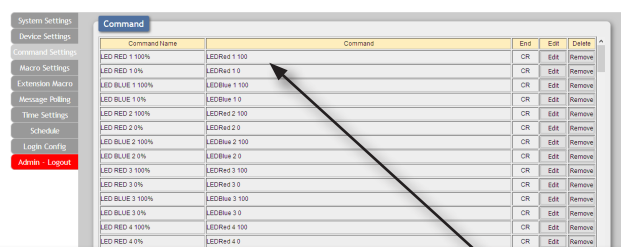

Command Name	Command
LED RED 1 100%	LEDRed 1 100
LED RED 1 0%	LEDRed 1 0
LED BLUE 1 100%	LEDBlue 1 100
LED BLUE 1 0%	LEDBlue 1 0
LED RED 2 100%	LEDRed 2 100
LED RED 2 0%	LEDRed 2 0
LED BLUE 2 100%	LEDBlue 2 100
LED BLUE 2 0%	LEDBlue 2 0

3. Click the **Add** button.

				Add	Remove
				Add	Remove
				Add	Remove
				Add	Remove
				Add	Remove
				Add	Remove
				Add	Remove
				Add	Remove
				Add	Remove
				Add	Remove

4. The **Command Edit** dialog will be displayed. In the example below, the dialog box title **Command 37 Edit** means that row 37 of the command list is being edited.
5. Enter the name of the command in the **Command Label** field. In this example, we will create the command to power-on the display that is connected to the AT-OME-ST31A. Set the value of this field to `Power On`.
6. Enter the command line information, required to turn on the display, in the **Command Data** field. The API for the AT-OME-ST31A states that the `DispBtn` command is used to power-on / power-off the connected display. The `on` argument is used to power-on the display. Therefore, the **Command Data** field is: `DispBtn on`.
7. Click the **End character** drop-down list to select the terminating character. This command requires a carriage return. Therefore, `CR` is selected from the drop-down list.
8. Click the **Save Changes** button to commit changes.

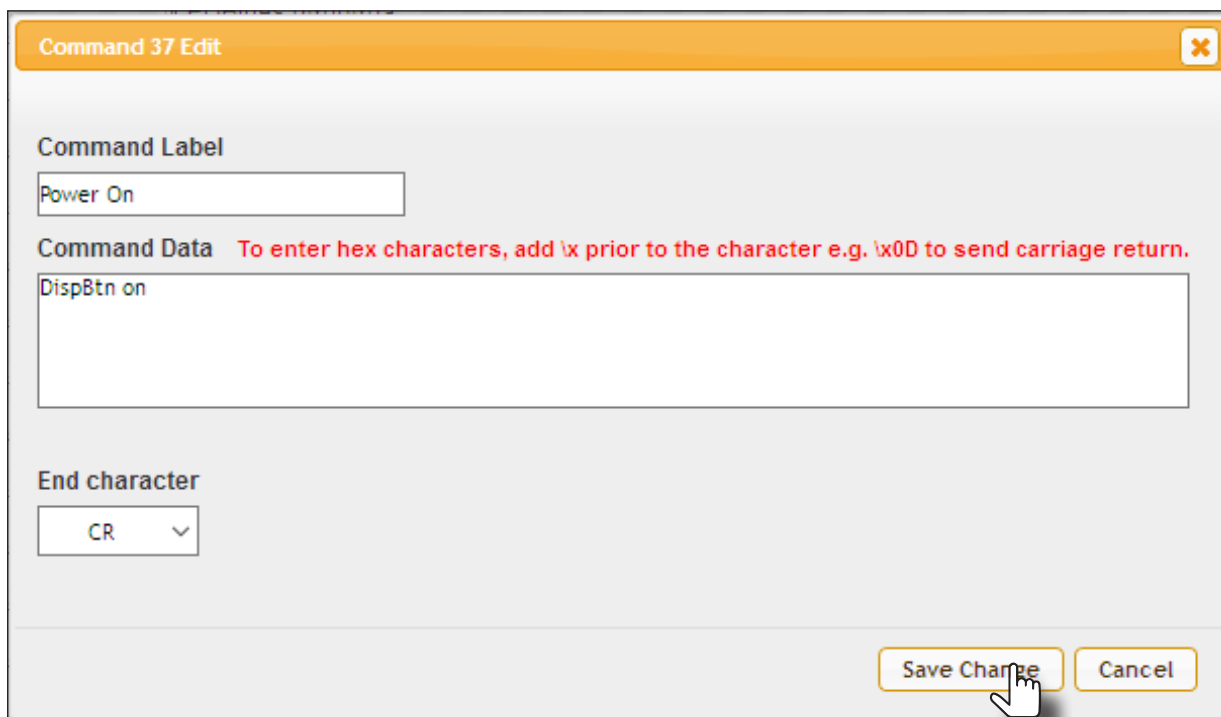

9. Create a Power Off command, following the steps above. For the Power Off command, enter the following data:

Command Label	<code>Power Off</code>
Command Data	<code>DispBtn off</code>
End character	<code>CR</code>

10. Finally, create a Display Status command. This command will be used to return the current power state of the display. Enter the following information for this command:

Command Label	<code>Display Status</code>
Command Data	<code>DispBtn sta</code>
End character	<code>CR</code>

Device Operation

11. Continue adding additional commands, as desired. The example below shows several more commands that have been added.
12. Click the **Edit** button to modify a command or click the **Remove** button to delete a command from the list.

Power On	DispBtn on	CR	Edit	Remove
Power Off	DispBtn off	CR	Edit	Remove
Mute On 1 (Button 2)	VOUtmute1 on	CR	Edit	Remove
Mute Off 1 (Button 2)	VOUtmute1 off	CR	Edit	Remove
Mute On 2 (Button 2)	VOUtmute2 on	CR	Edit	Remove
Mute Off 2 (Button 2)	VOUtmute2 off	CR	Edit	Remove
Mute On LR (Button 2)	LRAUD on	CR	Edit	Remove
Mute Off LR (Button 2)	LRAUD off	CR	Edit	Remove
USB-C Out 1 (Button 3)	x1A/x1	CR	Edit	Remove

Creating Macros

A macro is a series of steps or instructions that perform a certain task. This section will cover creating a macro by combining the commands that were created in the previous section with some default LED commands.

1. Click the **Macro Settings** tab.
2. Move the mouse over Button 1, in the upper-left corner, as shown.

Notice that a pop-up appears over the button. The information contained within the pop-up are the current macro settings for the button and will change, depending upon the button function. Currently, this button doesn't perform any function. However, for this example, we will create a macro to toggle power on the connected display, using the power-on and power-off commands. The power macro will be assigned to Button 1.

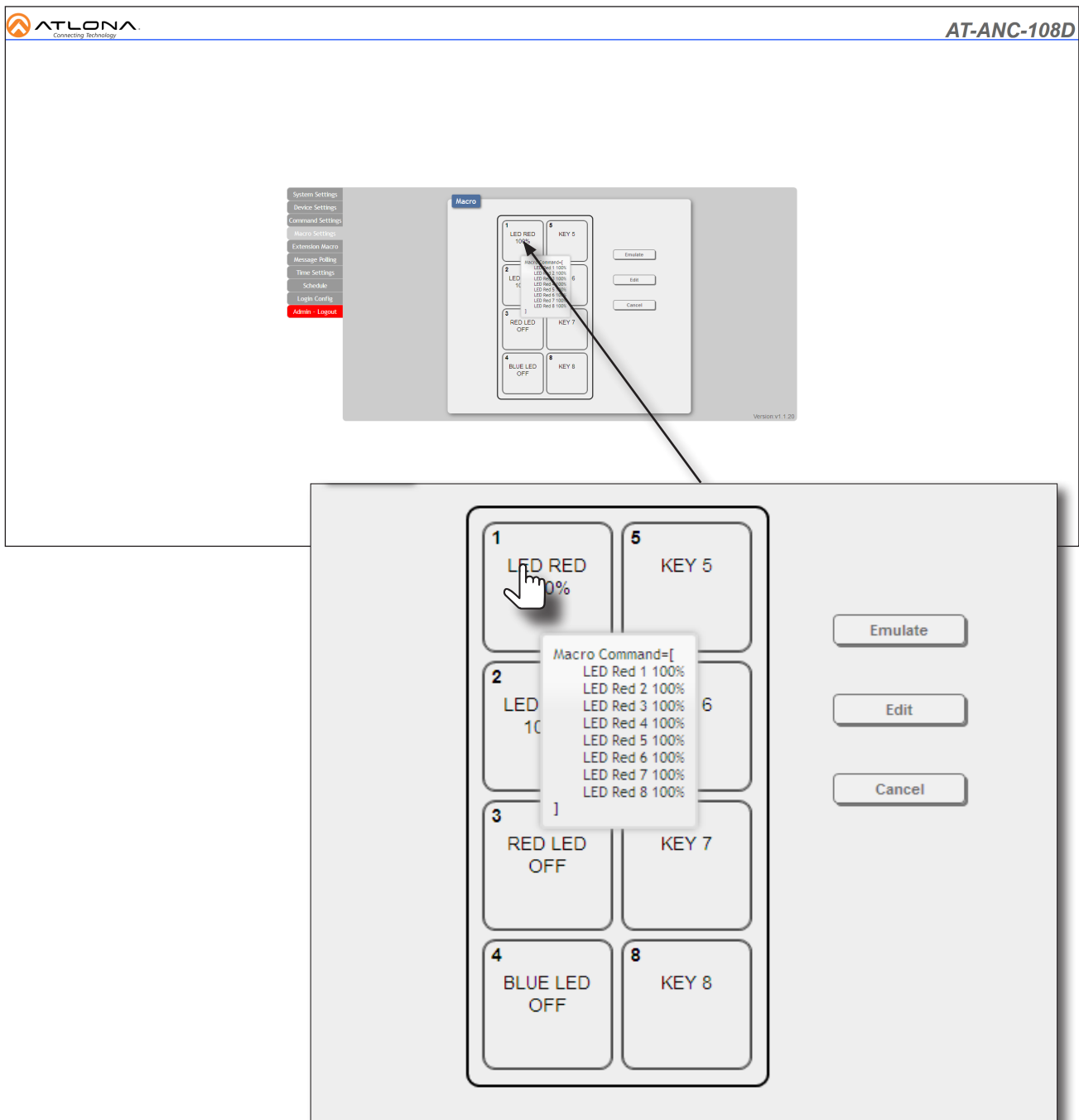

3. Click Button 1. The button will be highlighted in yellow.
4. Click the **Edit** button.

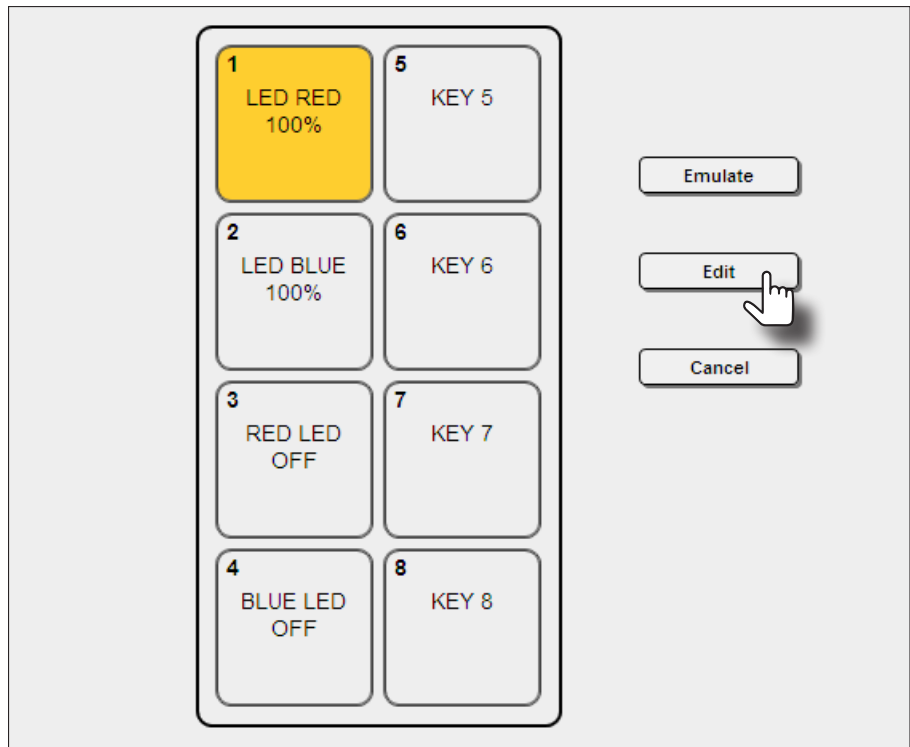

5. The **Macro Edit** dialog will be displayed.
6. Click the **Toggle** button and set it to **ENABLE**. This toggle must be set before commands are added to the macro. Once **Toggle** is enabled, two sections will appear in the **Macro Edit** dialog: the top row will be used to create a power-on macro and the bottom row will be used to create a power-off macro.

Macro 1 Edit

Macro 1 - LED RED 100%

Toggle

Repeat

LED RED 100%

ENABLE

DISABLE

Macro Command

Command Name	Interface	Param 1	Param 2	Delay(ms)			
Add							

Command Name	Interface	Param 1	Param 2	Delay(ms)			
Add							

- Click the **Add** button in the top row.

Macro 1 Edit

Macro 1 - LED RED 100%

Toggle

Repeat

ENABLE

DISABLE

Macro Command

Command Name	Interface	Param 1	Param 2	Delay(ms)			
Add							

Command Name	Interface	Param 1	Param 2	Delay(ms)			
Add							

- The **Command Select** dialog box will be displayed. This dialog box contains a list of all commands that have been created, including the default LED commands. Since this is a power toggle, a power-on and power-off macro will need to be created. We'll create the power-on macro first.
- Click the **Power On** command from the command list. This command was created in the previous section.

Command Select

LED Red 1 100%	LED Blue 5 0%	Mute On 1 (Button 2)	Device Power Off	NONE	NONE	NONE
LED Red 1 0%	LED Red 6 100%	Mute Off 1 (Button 2)	Device Power Status	NONE	NONE	NONE
LED Blue 1 100%	LED Red 6 0%	Mute On 2 (Button 2)	NONE	NONE	NONE	NONE
LED Blue 1 0%	LED Blue 6 100%	Mute Off 2 (Button 2)	NONE	NONE	NONE	NONE
LED Red 2 100%	LED Blue 6 0%	Mute On LR (Button 2)	NONE	NONE	NONE	NONE
LED Red 2 0%	LED Red 7 100%	Mute Off LR (Button 2)	NONE	NONE	NONE	NONE
LED Blue 2 100%	LED Red 7 0%	USB-C Out 1 (Button 3)	NONE	NONE	NONE	NONE
LED Blue 2 0%	LED Blue 7 100%	USB-C Out 2 (unused)	NONE	NONE	NONE	NONE
LED Red 3 100%	LED Blue 7 0%	Vol + (Button 5)	NONE	NONE	NONE	NONE
LED Red 3 0%	LED Red 8 100%	Vol - (Button 6)	NONE	NONE	NONE	NONE
LED Blue 3 100%	LED Red 8 0%	Mute 1 Status	NONE	NONE	NONE	NONE
LED Blue 3 0%	LED Blue 8 100%	Mute 2 Status	NONE	NONE	NONE	NONE
LED Red 4 100%	LED Blue 8 0%	Output Status	NONE	NONE	NONE	NONE
LED Red 4 0%	LED Red On 100%	HDMI 1 Out 1 (Button 4)	NONE	NONE	NONE	NONE
LED Blue 4 100%	LED Red Off 0%	HDMI 2 Out 1 (Button 8)	NONE	NONE	NONE	NONE
LED Blue 4 0%	LED Blue On 100%	HDMI 1 Out 2 (unused)	NONE	NONE	NONE	NONE
LED Red 5 100%	LED Blue Off 0%	HDMI 2 Out 2 (unused)	NONE	NONE	NONE	NONE
LED Red 5 0%	Power On	Display Status	NONE	NONE	NONE	NONE
LED Blue 5 100%	Power Off	Device Power On	NONE	NONE	NONE	NONE

10. The **Set Destination** dialog box will be displayed.

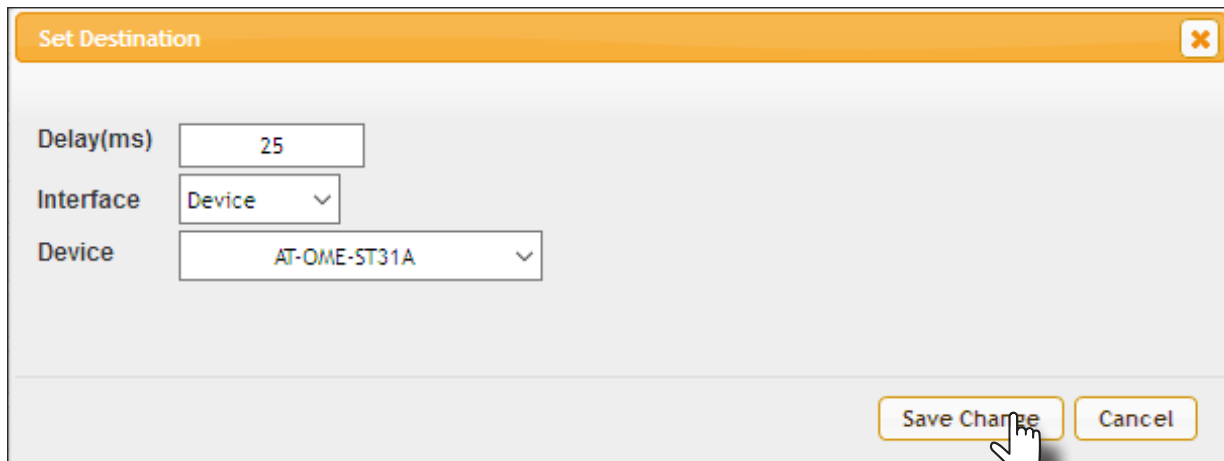

The **Set Destination** dialog box contains the following fields:

- Delay(ms)**: Text input field with the value `25`.
- Interface**: Drop-down menu with the selected value `Device`.
- Device**: Drop-down menu with the selected value `AT-OME-ST31A`.

At the bottom right, there are two buttons: **Save Change** and **Cancel**. A mouse cursor is pointing at the **Save Change** button.

11. Click the **Delay(ms)** field and specify the delay time.

12. Click the **Interface** drop-down list and select **Device**. This will allow an Atlona device to be selected.

13. Click the **Device** drop-down list and select the AT-OME-ST31A. The AT-OME-ST31A should be the only available selection. If additional devices were added to the **Device Settings** tab, then more options would be available from this drop-down list.

14. Click the **Save Changes** button to commit changes.

15. Click the **Add** button.

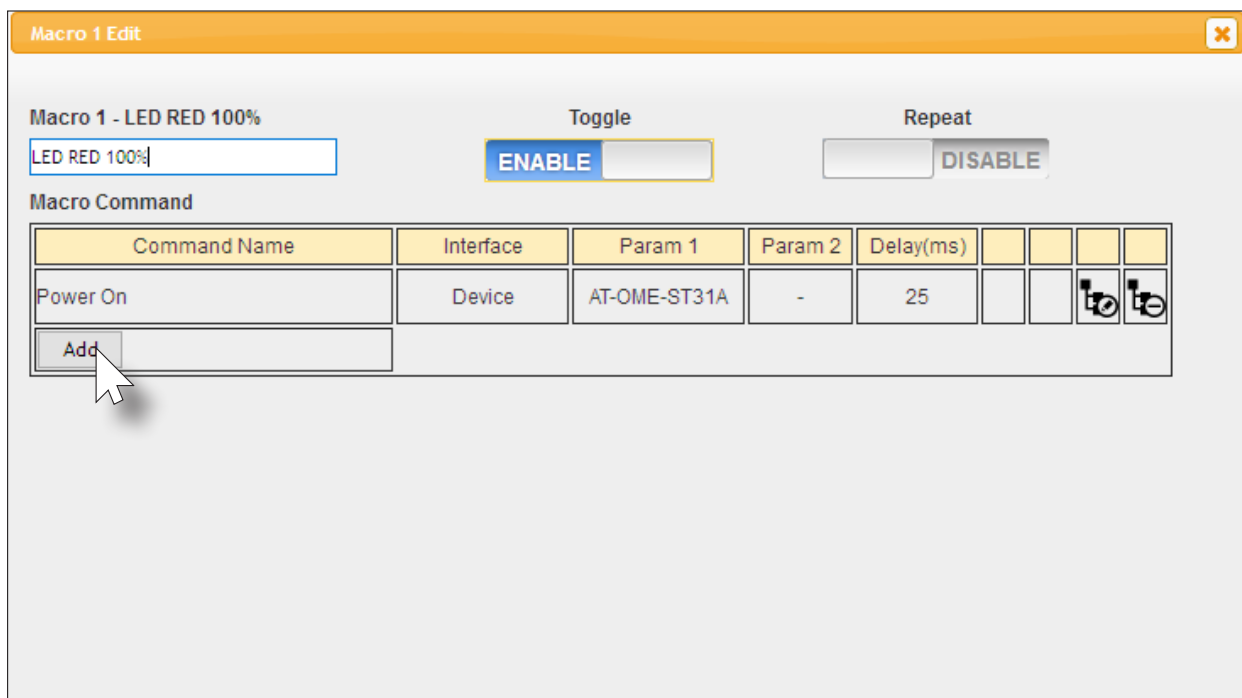

The **Macro 1 Edit** dialog box shows the following configuration:

- Macro 1 - LED RED 100%**: Text input field containing `LED RED 100%`.
- Toggle**: A button labeled **ENABLE** is active.
- Repeat**: A button labeled **DISABLE** is active.
- Macro Command**: A table with the following data:

Command Name	Interface	Param 1	Param 2	Delay(ms)				
Power On	Device	AT-OME-ST31A	-	25				
- Add**: A button at the bottom left of the table, with a mouse cursor pointing to it.

16. Add the following list of commands and set the **Delay** field to 25 and set the **Interface** to `SysCMD`.

```
LED Blue Off 0%           // initializes all blue LED to 0% visibility
LED Red Off 0%           // initializes all red LED to 0% visibility
LED Blue 1 100%         // sets Button 1 blue LED to 100% visibility
```

- Change the field under **Macro 1 - LED RED 100%** to read `PWR`. This will be the name of the power macro.
- Once all changes are made, the **Macro Edit** dialog should look like the illustration below.

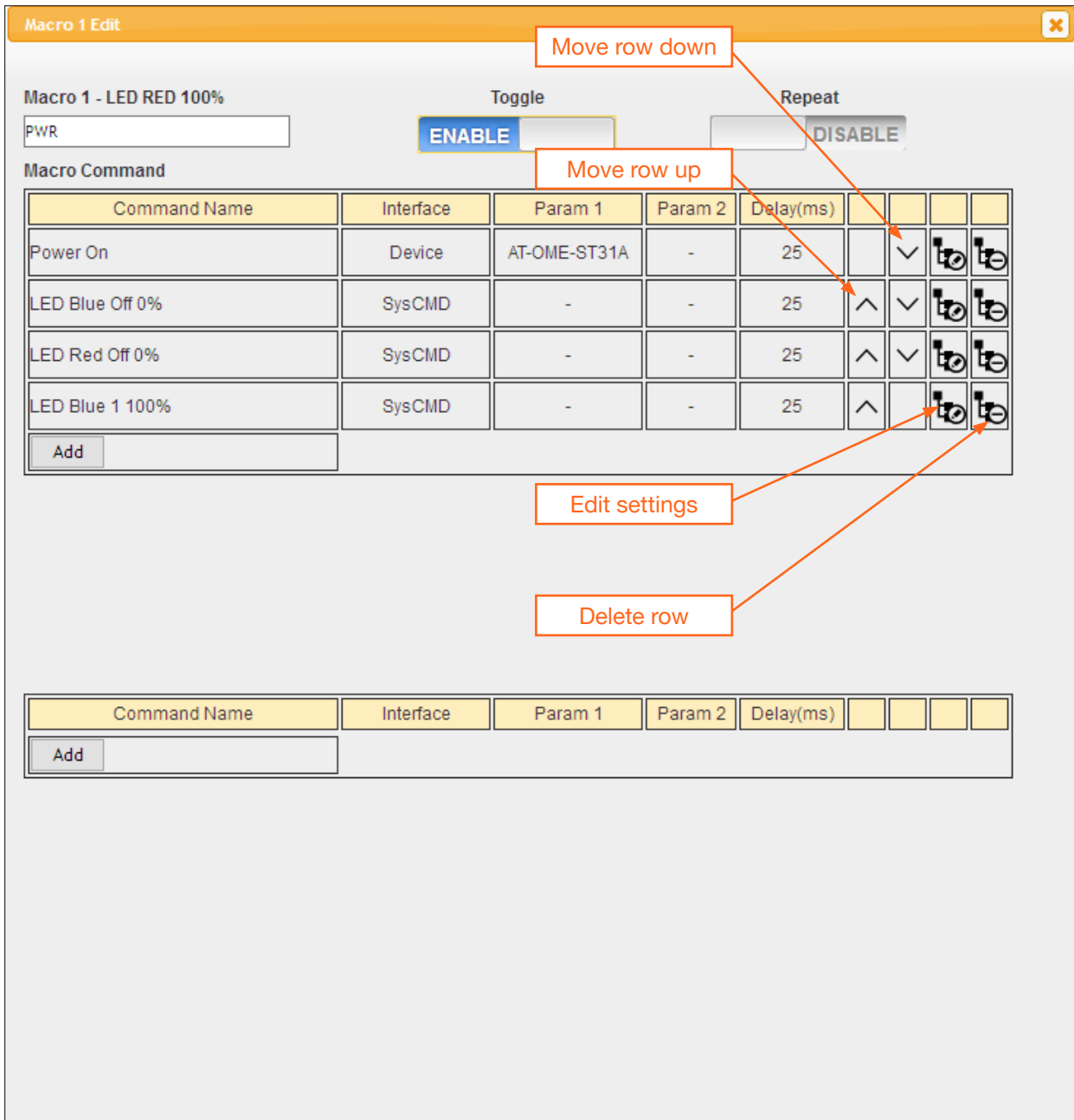

Macro 1 Edit

Macro 1 - LED RED 100%

PWR

Toggle: ENABLE, DISABLE

Repeat: Repeat, DISABLE

Command Name	Interface	Param 1	Param 2	Delay(ms)				
Power On	Device	AT-OME-ST31A	-	25	✓	⚙️	🗑️	
LED Blue Off 0%	SysCMD	-	-	25	^	⚙️	🗑️	
LED Red Off 0%	SysCMD	-	-	25	^	⚙️	🗑️	
LED Blue 1 100%	SysCMD	-	-	25	^	⚙️	🗑️	

Add

Command Name	Interface	Param 1	Param 2	Delay(ms)				

Add

- Create the power-off macro, in the bottom section, using the following information. Note that the `SysCMD` interface type specifies that this is a system-level AT-ANC-108D instruction.

Power Off	Device	AT-OME-ST31A	25
LED Blue Off 0%	SysCMD		25
LED Red Off 0%	SysCMD		25
LED Red 1 100%	SysCMD		25

20. The power macro should look like the following illustration.

21. Click the **Save Changes** button to commit changes. The “Wait....” message will appear, as changes are saved.

Macro 1 Edit
✕

Macro 1 - PWR

PWR

Toggle

 ENABLE

Repeat

 DISABLE

Macro Command

Command Name	Interface	Param 1	Param 2	Delay(ms)				
Power On	Device	AT-OME-ST31A	-	25		∨	🔍	🔍
LED Blue Off 0%	SysCMD	-	-	25	∧	∨	🔍	🔍
LED Red Off 0%	SysCMD	-	-	25	∧	∨	🔍	🔍
LED Blue 1 100%	SysCMD	-	-	25	∧		🔍	🔍
<input type="button" value="Add"/>								

Command Name	Interface	Param 1	Param 2	Delay(ms)				
Power Off	Device	AT-OME-ST31A	-	25		∨	🔍	🔍
LED Blue Off 0%	SysCMD	-	-	25	∧	∨	🔍	🔍
LED Red Off 0%	SysCMD	-	-	25	∧	∨	🔍	🔍
LED Red 1 100%	SysCMD	-	-	25	∧		🔍	🔍
<input type="button" value="Add"/>								

22. The PWR macro configuration is complete.

Configuring Extension Macros

Up to this point, the macro is in place for toggling the display power ON or OFF. The next step is to configure the LED indicators on the front panel of the AT-ANC-108D. Extension Macros are required in order for the buttons on the AT-ANC-108D to display the current state of a device.

1. Click the **Extension Macro** tab.



NOTE: The Extension Macro tab functions differently than the Macro Settings tab. When setting up button behavior for the AT-ANC-108D, it is not necessary to assign a macro to the same button that is used to perform a function. For instance, in the examples on the previous page, the PWR macro was assigned to Button 1. Here, we will use Button 15 and Button 16 to control the LED indicator of Button 1.

2. Click the **KEY 15** button.
3. Click the **Edit** button.

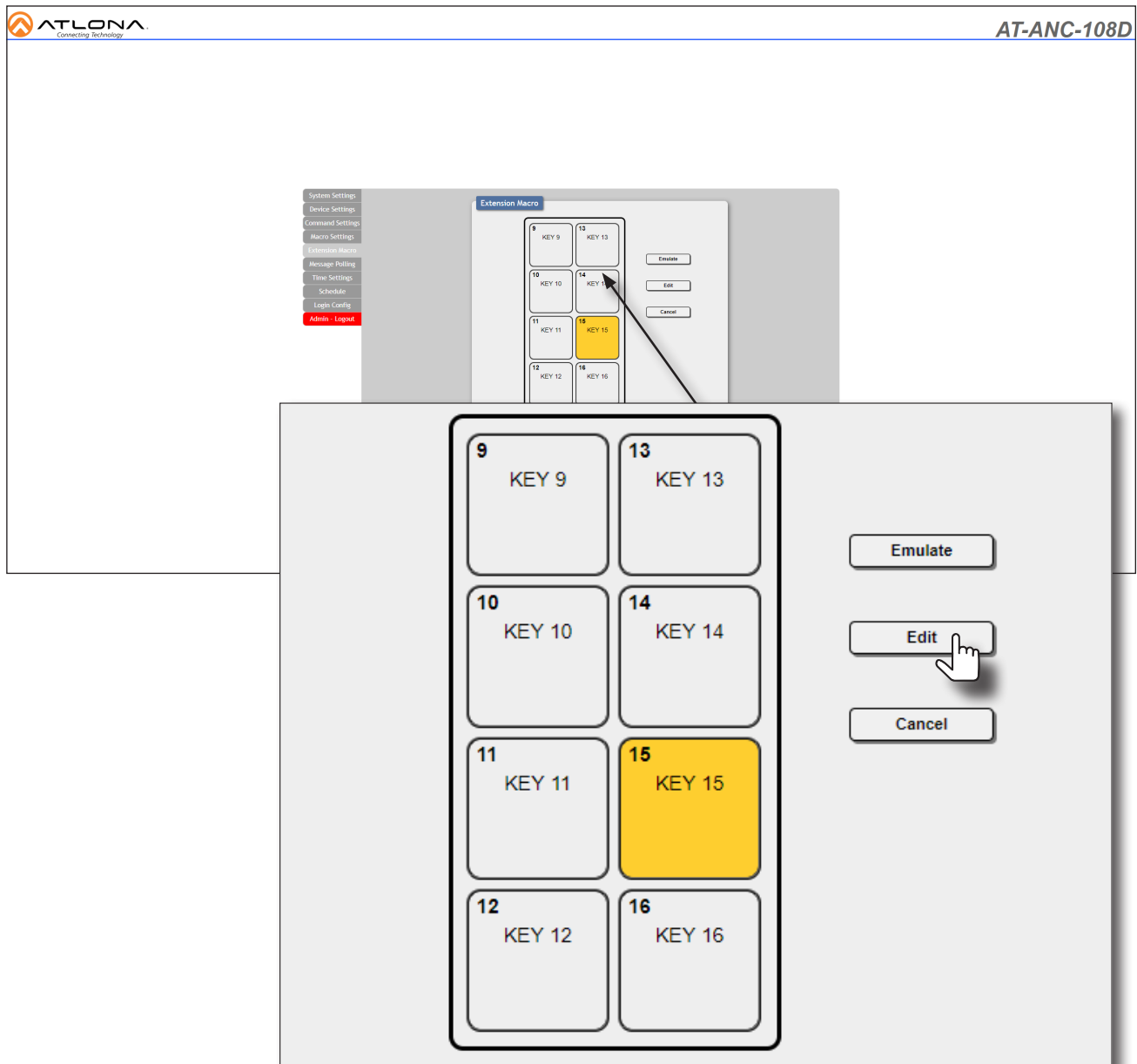

The screenshot shows the AT-ANC-108D web interface. The top left corner displays the ATLONA logo and the text "Connecting Technology". The top right corner displays "AT-ANC-108D". The main content area shows a sidebar menu on the left with options: System Settings, Device Settings, Command Settings, Macro Settings, Extension Macro (highlighted), Message Polling, Time Settings, Schedule, Login Config, and Admin - Logout. The main area displays the "Extension Macro" configuration screen. It features a grid of 16 keys (KEY 9 to KEY 16) and three buttons: Emulate, Edit, and Cancel. Key 15 is highlighted in yellow, and the Edit button is being clicked by a mouse cursor.

- Click the **Add** button.

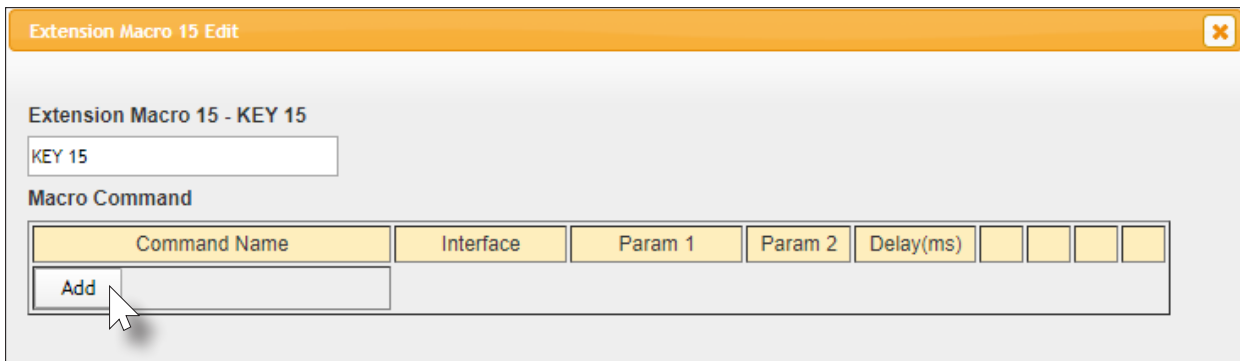

- From the **Command Select** dialog, click LED Blue 1 100%. Selecting this option will set Button 1 to turn blue at 100% brightness.

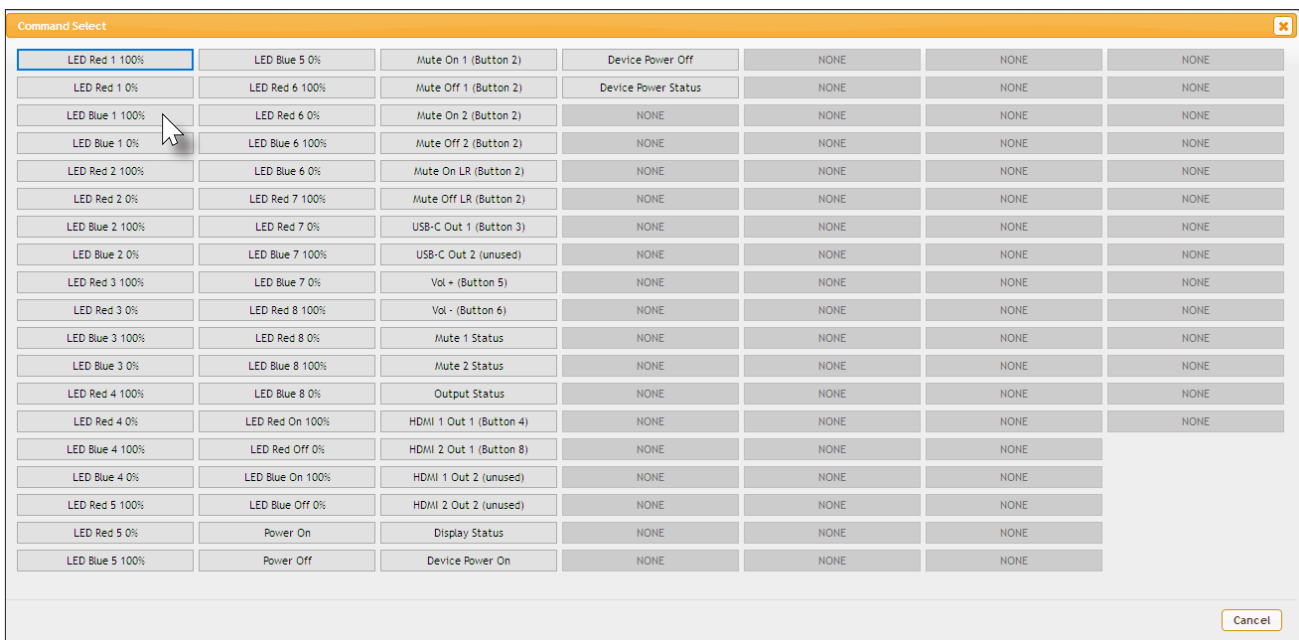

- The **Select Destination** dialog will be displayed. Click in the **Delay(ms)** field and set this value to 25.
- Select `sysCMD` from the Interface drop-down list, if it is not already selected. The `sysCMD` option tells the AT-ANC-108D that this command is a system-exclusive message.

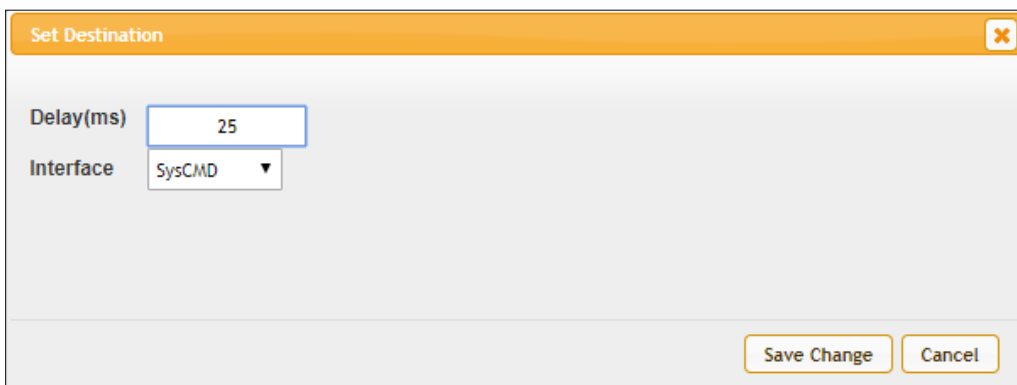

- Click the **Save Change** button to commit changes.
- The **Extension Macro Edit 15** dialog will be displayed. Repeat Steps 4 through 8 and add the following. Under the Set Destination dialog, the **Delay(ms)** field and **Interface** drop-down list should be set to 25 and SysCMD, respectively.

LED Red 1 0% SysCMD 25

This command will turn off the red LED for button 1.

- Click the **Save Changes** button to commit changes.
- Change the name of the macro in the **Extension Macro 15 - KEY 15** field to `Power On LED`.
- Click the **Save Changes** button at the bottom of the **Extension Macro 15 Edit** dialog to commit changes.

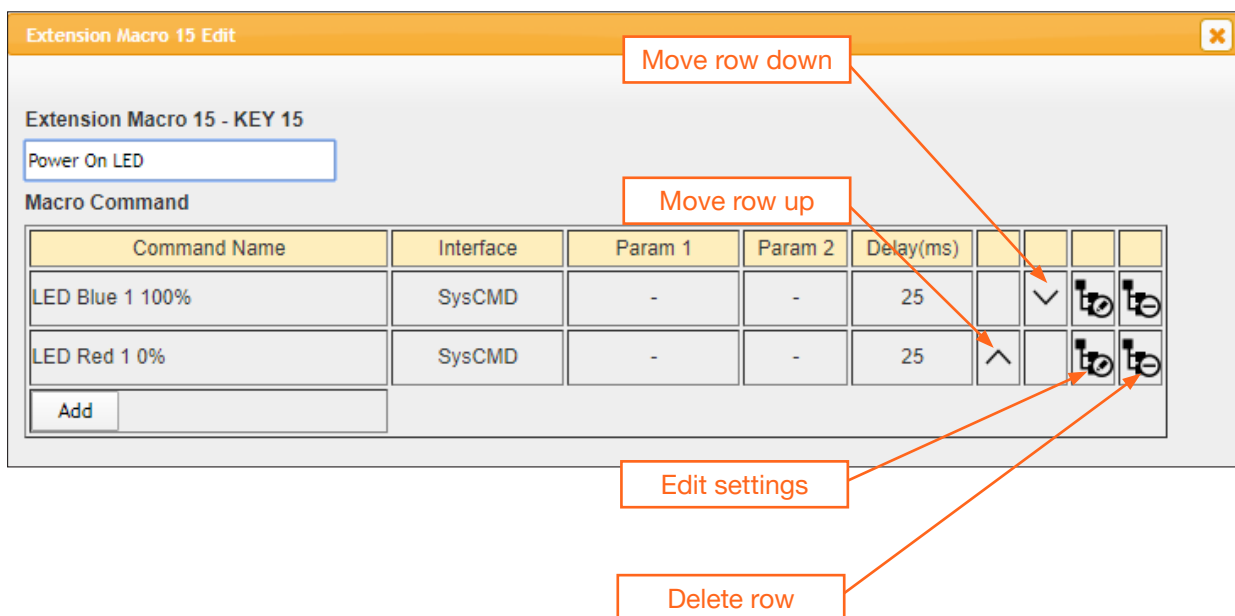

- Repeat the above steps for the **KEY 16** button to create a Power Off LED extension macro. Use the following information. The following instructions will set the red LED at 100% brightness and the blue LED to 0% for Button 1, when the display power is in the OFF state. Note that the order in which these commands are entered is not important.

LED Blue 1 0% SysCMD 25
 LED Red 1 100% SysCMD 25

- Change the name of the macro in the **Extension Macro 16 - KEY 16** field to `Power Off LED`.
- Save all changes.
- Extension macro configuration for the Power On and Power Off LED for Button 1 is complete.

Message Polling

The final step is to create the polling for the AT-ANC-108D. Polling is the process by which the AT-ANC-108D actively samples the current state of a device. Once the AT-ANC-108D receives the state of the device, it can be processed. Depending upon the returned value, the AT-ANC-108D can then change colors of the LED indicators or execute another macro.

1. Click the **Message Polling** tab.
2. Click the **Add** button in the first row.

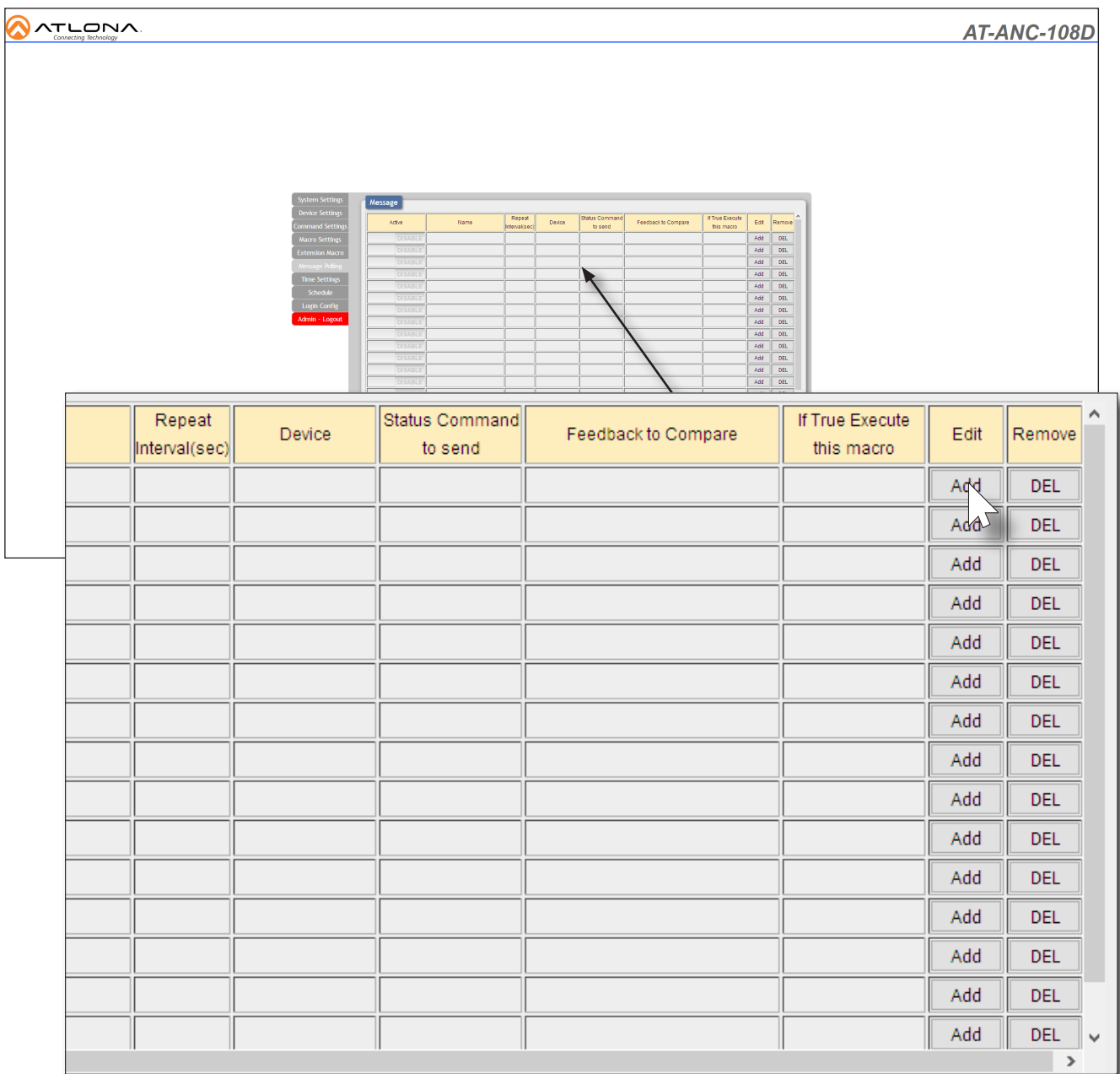

The screenshot shows the AT-ANC-108D web interface with the 'Message' configuration table. The table has the following columns: Active, Name, Repeat Interval(sec), Device, Status Command to send, Feedback to Compare, If True Execute this macro, Edit, and Remove. The 'Add' button in the first row is highlighted by a mouse cursor. An inset window shows a detailed view of the table with an arrow pointing to the 'Add' button in the first row.

Active	Name	Repeat Interval(sec)	Device	Status Command to send	Feedback to Compare	If True Execute this macro	Edit	Remove
DISABLE							Add	DEL
DISABLE							Add	DEL
DISABLE							Add	DEL
DISABLE							Add	DEL
DISABLE							Add	DEL
DISABLE							Add	DEL
DISABLE							Add	DEL
DISABLE							Add	DEL
DISABLE							Add	DEL
DISABLE							Add	DEL
DISABLE							Add	DEL
DISABLE							Add	DEL
DISABLE							Add	DEL
DISABLE							Add	DEL
DISABLE							Add	DEL
DISABLE							Add	DEL
DISABLE							Add	DEL
DISABLE							Add	DEL
DISABLE							Add	DEL
DISABLE							Add	DEL
DISABLE							Add	DEL
DISABLE							Add	DEL

3. The **Device 1 Edit** dialog will be displayed.

Device Operation

- In the **Name** field, enter the value `Power Status On`, then set the **Repeat Interval(sec)** field to 1. The value of 1 indicates that the query will be performed every second.
- Click the **Device** drop-down list and select the desired device. In this example, the AT-OME-ST31A is the device being controlled.

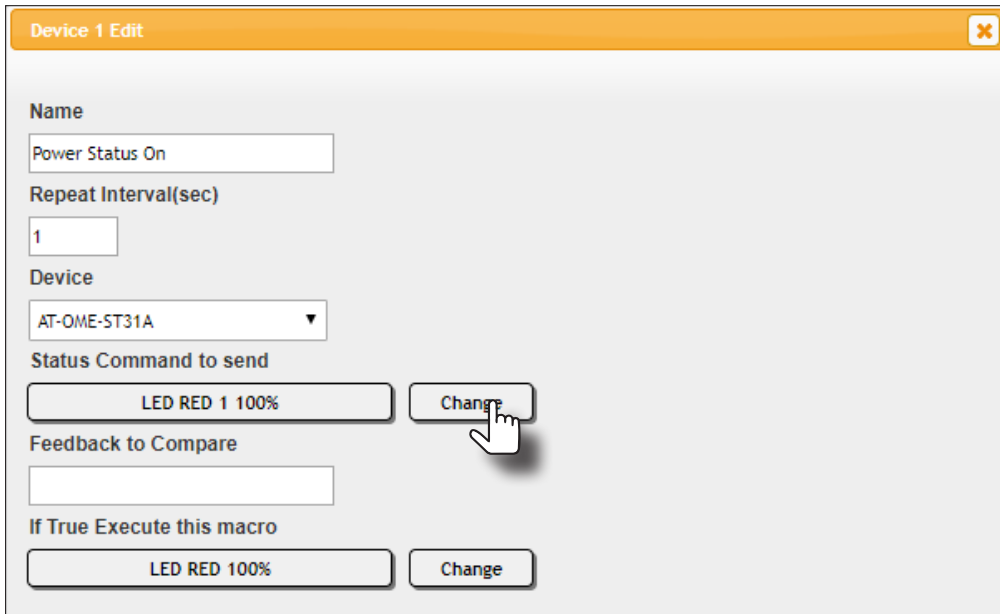

- Click the **Change** button to display the **Command Select** dialog.
- Select `Display Status` from the command list. This will execute the `DispBtn sta` command and return the power state of the display.
- In the **Feedback to Compare** field, enter `DispBtn on`. This is the value that will need to be compared in order for the AT-ANC-108D to turn Button 1 either blue (on) or red (off).
- Click the **Change** button to display the **Macro Select** dialog, then click the `Power On LED Extension Macro`. If the display is powered on (true), then the `Power On LED Extension Macro` will be executed. This will set the blue LED to 100% brightness for Button 1, reporting that the display is in the “ON” state.

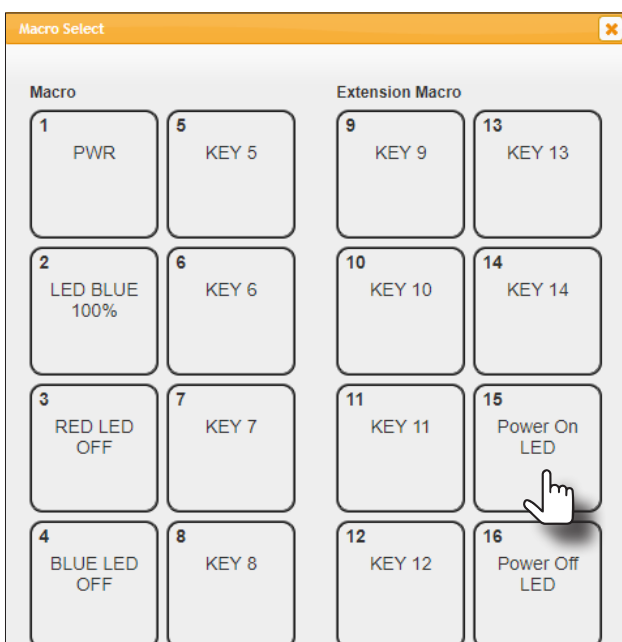

Device Operation

- Click the **Save Changes** button on the **Device 1 Edit** dialog.
- Next, create a Power Status Off message poll, using the steps above. This poll will check for a power off state. Add the following information to each field within the **Device 2 Edit** dialog box:

Name	Power Status Off	
Repeat Interval(sec)	1	
Device	AT-OME-ST31A	// example device
Status Command to send	Display Status	
Feedback to Compare	DispBtn off	
If True Execute this macro	Power Off LED	// button 16

- Click the **Save Changes** button on the **Device 2 Edit** dialog.
- The Message Polling tab should now look similar to the following. Note that once a polling message has been added, the **Active** toggle switch will automatically be set to **ENABLE**.

Active	Name	Repeat Interval(sec)	Device	Status Command to send	Feedback to Compare	If True Execute this macro	Edit	Remove
<input checked="" type="checkbox"/>	Power Status On	1	AT-OME-ST31A	Display Status	DispBtn on	Power On LED	Edit	DEL
<input checked="" type="checkbox"/>	Power Status Off	1	AT-OME-ST31A	Display Status	DispBtn off	Power Off LED	Edit	DEL
<input type="checkbox"/>							Add	DEL
<input type="checkbox"/>							Add	DEL
<input type="checkbox"/>							Add	DEL
<input type="checkbox"/>							Add	DEL
<input type="checkbox"/>							Add	DEL
<input type="checkbox"/>							Add	DEL
<input type="checkbox"/>							Add	DEL
<input type="checkbox"/>							Add	DEL
<input type="checkbox"/>							Add	DEL
<input type="checkbox"/>							Add	DEL
<input type="checkbox"/>							Add	DEL
<input type="checkbox"/>							Add	DEL
<input type="checkbox"/>							Add	DEL
<input type="checkbox"/>							Add	DEL

- Message polling for the power state is complete.

Testing Macros

It is useful to test a macro, after creating it, to make sure that it performs the desired function. Testing a macro is done within the **Macro Settings** tab.

1. Click the **Macro Settings** tab.
2. Click the button that contains the macro to be tested. In this example, we will test the power macro we just created. Click the **PWR** button.
3. Click the **Emulate** button.

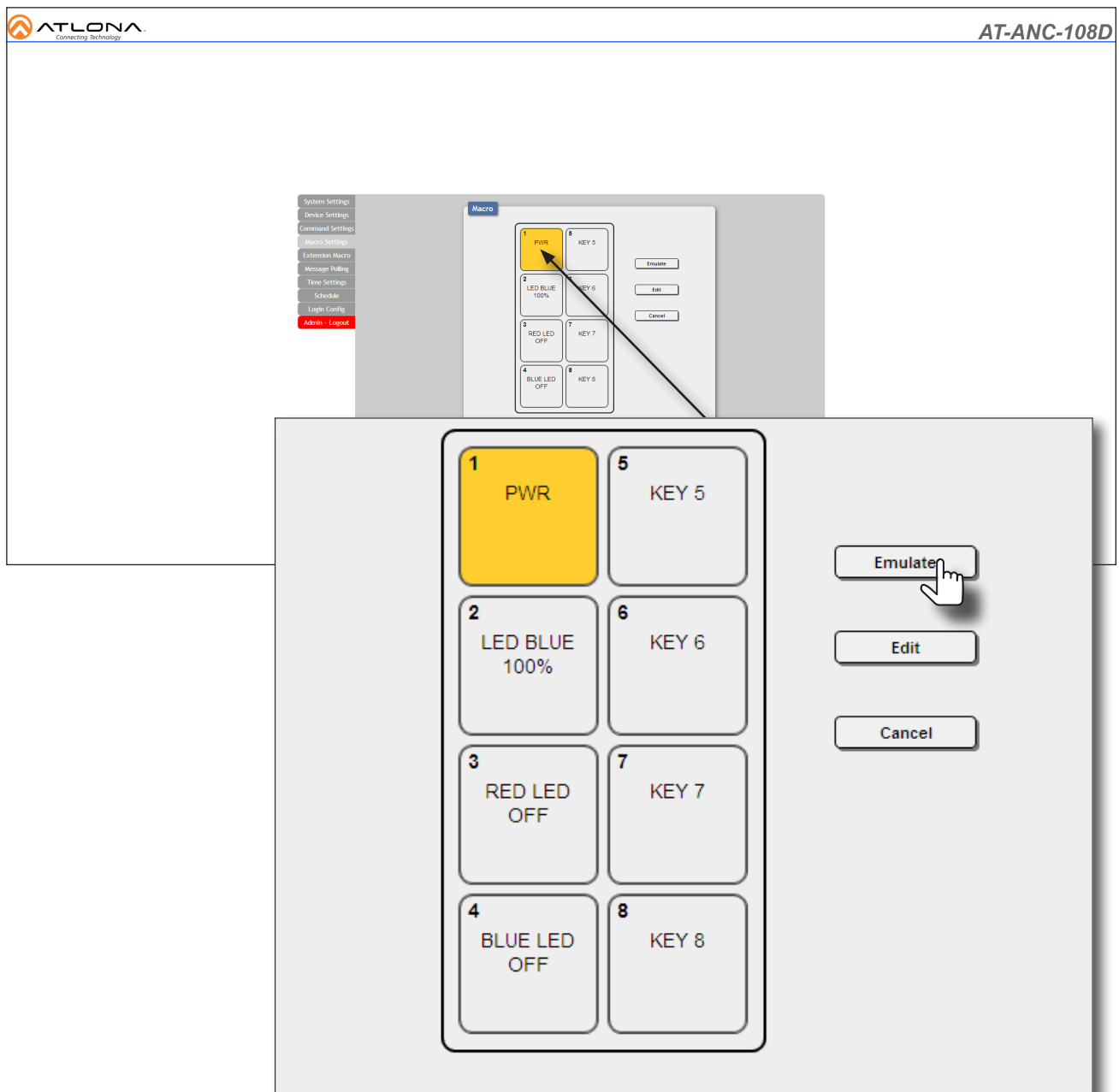

- Check the front panel of the AT-ANC-108D. The associated button on the AT-ANC-108D should be active.

In this example, since a power toggle macro is being executed, the button will change color based on the state of the display. Therefore, if the display is in a powered-on state, Button 1 will be blue. If the connected display is powered-off, then Button 1 will be red. The example below shows a blue power toggle button, indicating that the display is now powered.

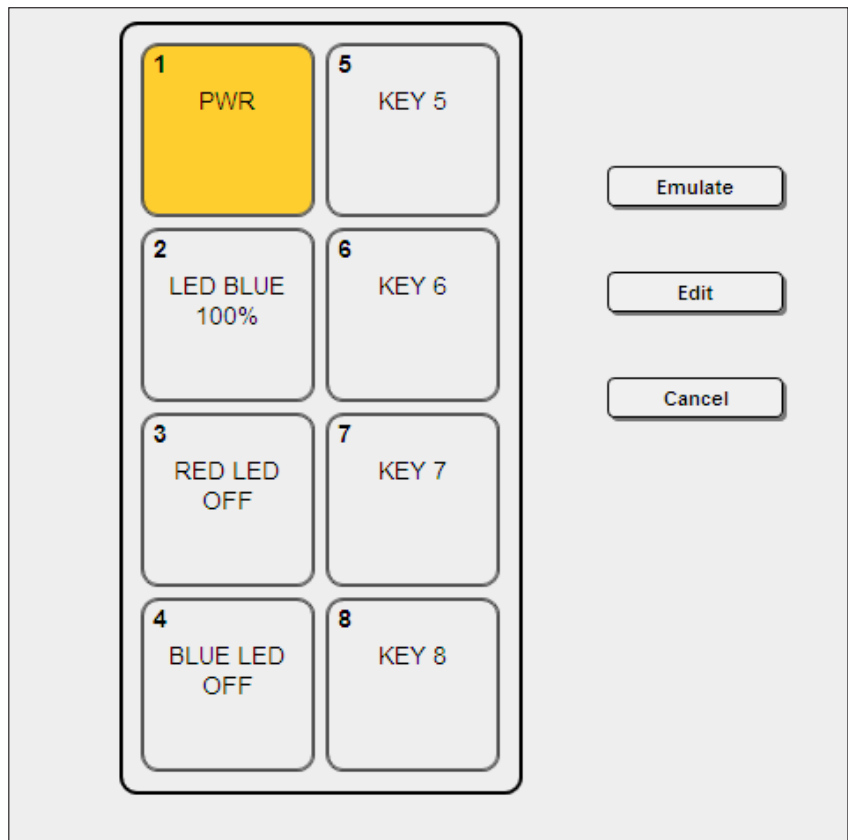
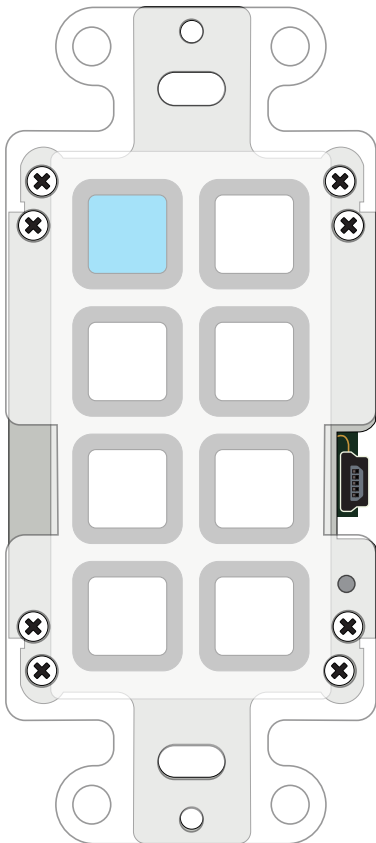

- Macro testing is complete. If the macro doesn't perform as desired, click the **Edit** button for the selected button and check all macro and command settings.

Velocity™

Using the AMS Device Manager

The AMS Device Manager, within Velocity™, can also be used to configure and control the AT-ANC-108D. AMS is now a part of the Velocity System, and may be accessed with a VGW-HW hardware gateway, VGW-SW software gateway, or as a virtual machine software download.

1. Launch a web browser and enter the IP address of Velocity in the address bar.
2. Enter the required login credentials.
3. Click the **Login** button.
4. The Velocity Home screen will be displayed.
5. Click the ☰ icon, in the upper-left corner of the Velocity Dashboard.
6. Click **Management > AMS Device Manager**.

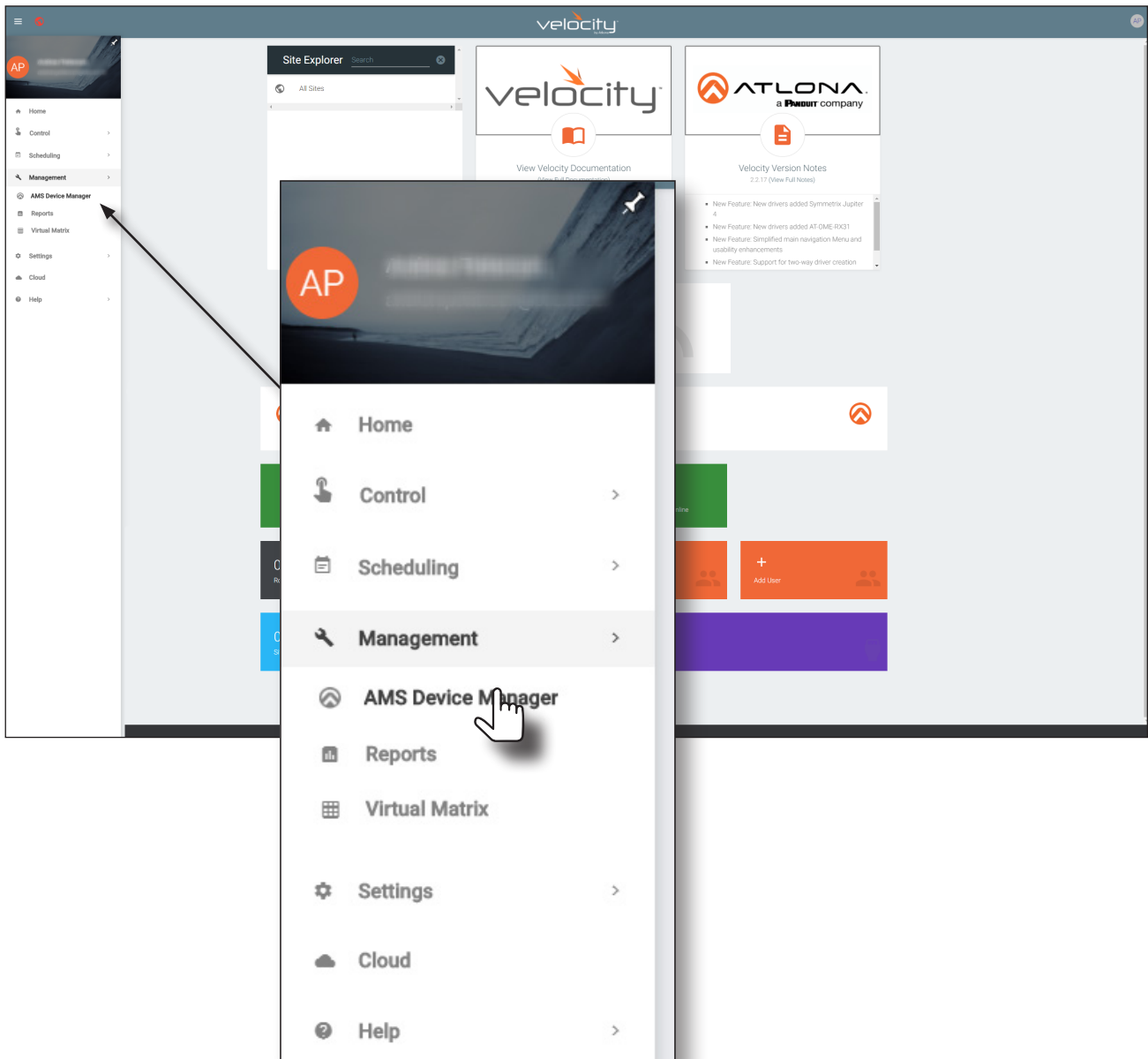

7. The **Device List** page will be displayed.
8. Click the AT-ANC-108D in the **Device List** window.



IMPORTANT: If the AT-ANC-108D does not appear in the **Device List** window, click the **SCAN** button to perform a network scan of all connected devices. Velocity will only be able to detect the AT-ANC-108D if both Velocity and the AT-ANC-108D are connected to the same VLAN.

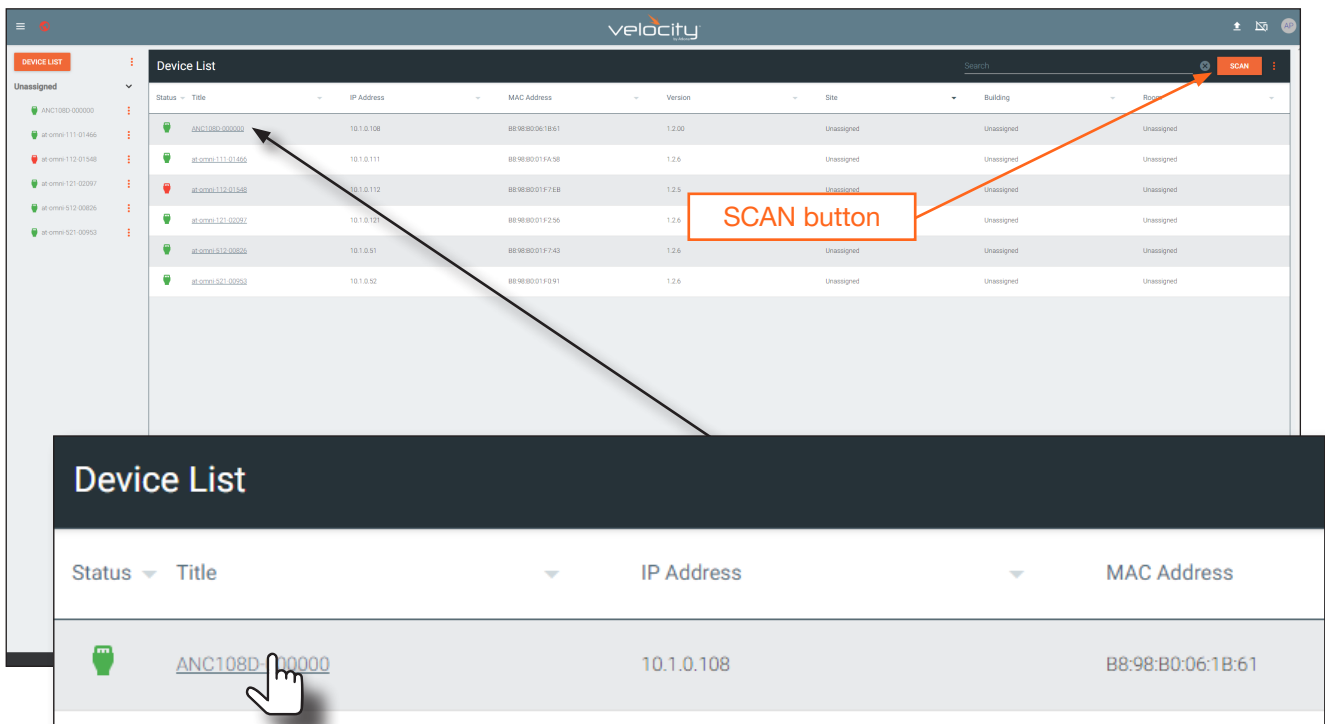

Status	Title	IP Address	MAC Address	Version	Site	Building	Room
Unassigned	ANC108D-00000	10.1.0.108	B8:98:06:1B:61	1.2.00	Unassigned	Unassigned	Unassigned
Unassigned	at-omei-111-01466	10.1.0.111	B8:98:0D:1F:43B	1.2.6	Unassigned	Unassigned	Unassigned
Unassigned	at-omei-112-01548	10.1.0.112	B8:98:0D:1F:7EB	1.2.5	Unassigned	Unassigned	Unassigned
Unassigned	at-omei-121-02097	10.1.0.121	B8:98:0D:1F:236	1.2.6	Unassigned	Unassigned	Unassigned
Unassigned	at-omei-512-00826	10.1.0.51	B8:98:0D:1F:743	1.2.6	Unassigned	Unassigned	Unassigned
Unassigned	at-omei-521-00953	10.1.0.52	B8:98:0D:1F:891	1.2.6	Unassigned	Unassigned	Unassigned

9. The **DEVICE INFO** page for the AT-ANC-108D will be displayed. Click **CONFIGURATION** in the top menu bar.

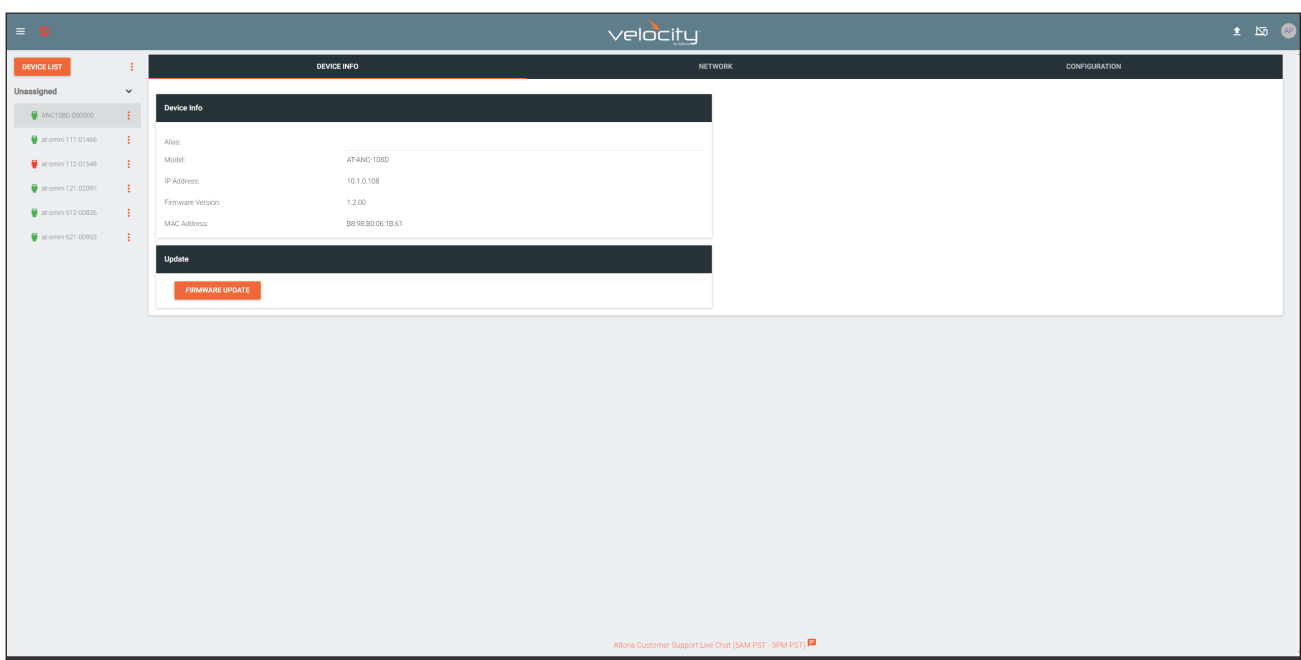

Field	Value
Alias	
Model	AT-ANC-108D
IP Address	10.1.0.108
Firmware Version	1.2.00
MAC Address	B8:98:0D:06:1B:61

Update

[FIRMWARE UPDATE](#)

10. The **CONFIGURATION** page will be displayed.

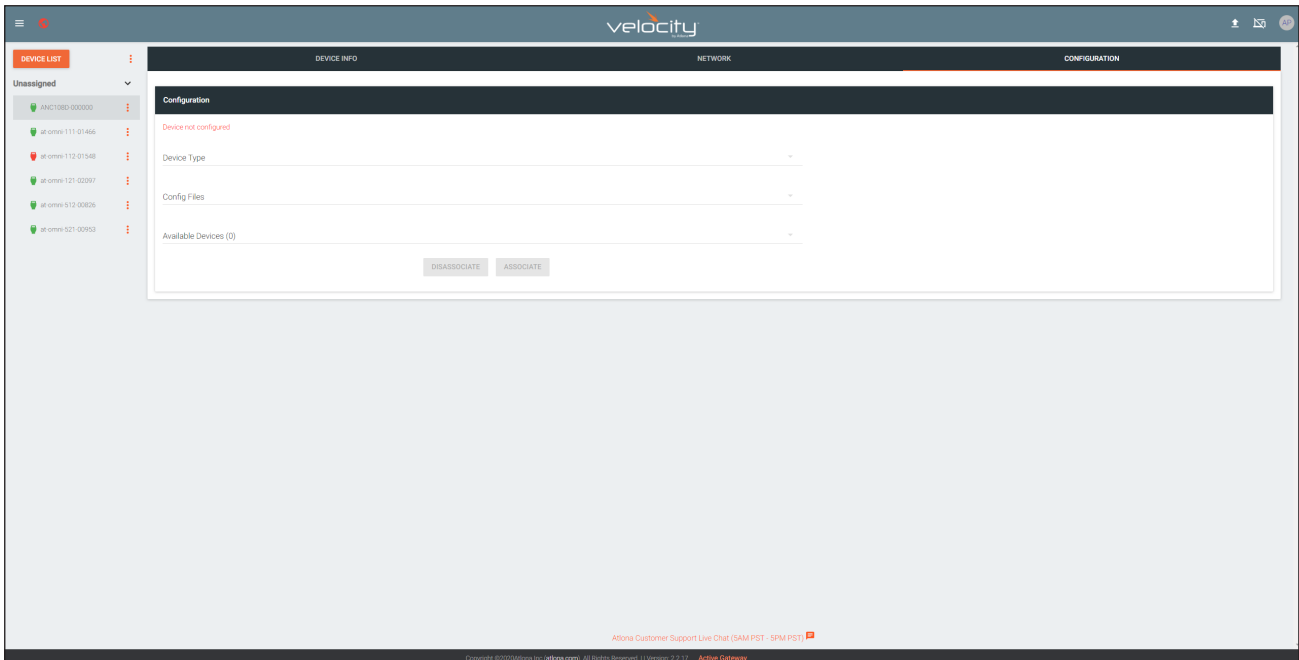

11. Click the **Device Type** drop-down list and select the device to be controlled by the AT-ANC-108D. In this example, the AT-HD-SC-500 is selected.

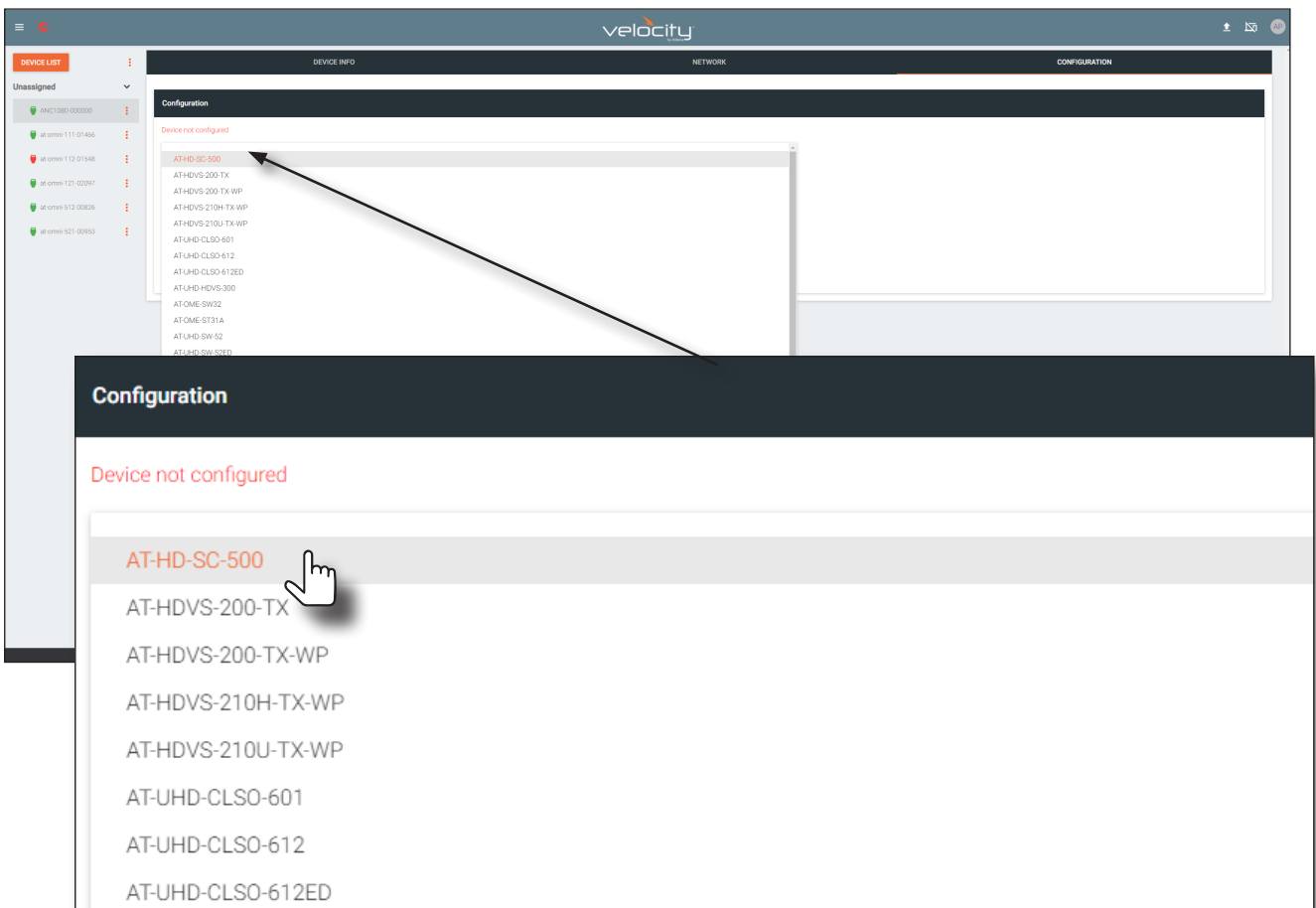

12. Click the **Config Files** drop-down list and select the configuration file.



Configuration

Device not configured

Device Type
AT-HD-SC-500

AT-HD-SC-500.XML

Available Devices (0)

DISASSOCIATE ASSOCIATE

Appendix

Updating the Firmware

The following procedure outlines the firmware update procedure for the AT-ANC-108D using the USB port. Download the firmware from the AT-ANC-108D product page on the Atlona web site.



NOTE: If the AT-ANC-108D is powered using Power over Ethernet (PoE), then substitute the Ethernet cable for the power supply in Step 2.

1. Disconnect the power from the AT-ANC-108D.
2. Press and hold **Button 1** while connecting power to the power receptacle on the rear of the unit. **Button 1** will flash three times, indicating that it is in firmware-update mode.

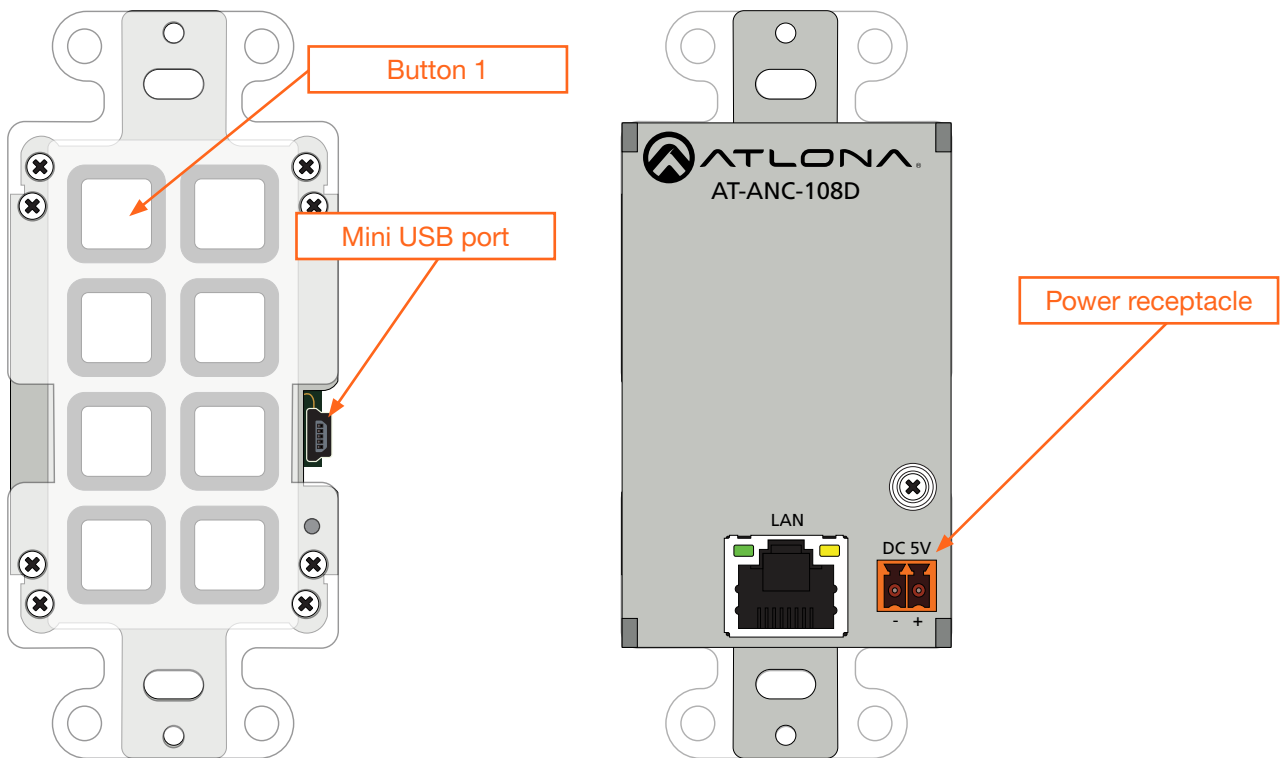

3. Connect a USB to mini-USB cable from the computer to the mini-USB port.
4. The USB UPDATE folder will be displayed. If this folder is not displayed, automatically, select the USB UPDATE drive from Windows Explorer.

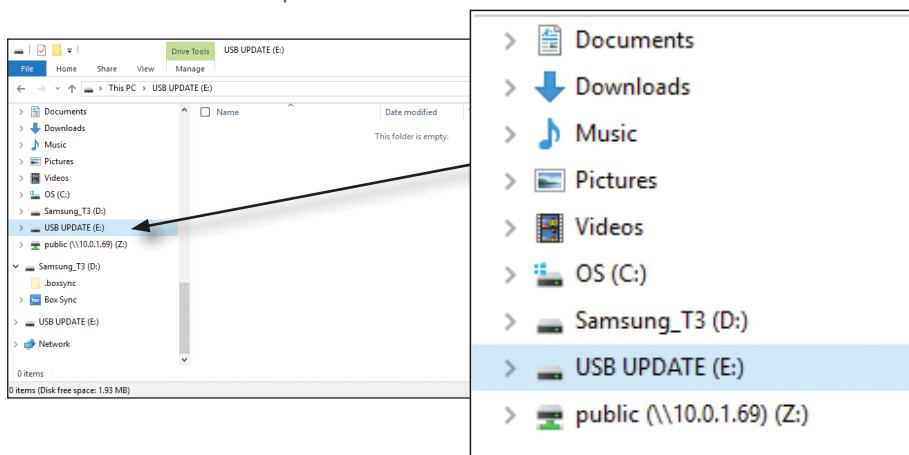

5. Delete all files from the USB UPDATE drive, if any are present.
6. Drag-and-drop the firmware file to the drive folder. Once the firmware update process has completed, the USB UPDATE folder will close, automatically.
7. Disconnect the USB cable from the AT-ANC-108D. The unit is now ready for use.

Specifications

Protocols	
Addressing	DHCP, static
Management	Telnet

Control	
IP	Protocols: HTTP, Telnet Modes: DHCP, Static – selectable through front panel and webGUI

Connectors, Controls, and Indicators	
LAN	1 - RJ45, 100Base-T
USB	1 - Mini-USB, Type B
DC 5V	1 - 2-pin captive screw
RESET	1 - push button, recessed, tact-type
Control Buttons	8 - push button, tact-type

Distance	Feet	Meters
Per hop of Ethernet cable	330	100

Temperature	Fahrenheit	Celsius
Operating	32 to 104	0 to 40
Storage Temperature	-4 to 140	-20 to 60
Operating Humidity (RH)	20% to 90%, non-condensing	

Power	
Consumption	3.3 W
BTU/h	11.3
External Power Supply	100 - 240 V AC, 50/60 Hz Output: 5 V / 2.6 A DC

Dimensions	Inches	Millimeters
Device (H x W x D)	4.49 x 2.71 x 1.50	114 x 69 x 38

Weight	Pounds	Kilograms
Device	0.33	0.15

Certification	
Device	CE, FCC
Power Supply	CE, FCC, Level IV, RoHS, cULus, RCM, CCC

Compliance	
NDAA-899	Yes
TAA	Yes

Warranty	
Device	To view the product warranty, use the following link: https://atlon.com/warranty

