

Network Enabled Occupancy Sensor



Version Information

Version	Release Date	Notes
14	Dec 2023	Updated warranty information

Sales, Marketing, and Customer Support

Main Office

Atlona Incorporated
70 Daggett Drive
San Jose, CA 95134
United States

Office: +1.408.962.0515

Sales and Customer Service Hours
Monday - Friday: 6:00 a.m. - 4:30 p.m. (PST)

<https://atlona.com/>

International Headquarters

Atlona International AG
Tödistrasse 18
8002 Zürich
Switzerland

Office: +41.43.508.4321

Sales and Customer Service Hours
Monday - Friday: 09:00 - 17:00 (UTC +1)

Operating Notes



IMPORTANT: Visit <https://atlona.com/product/at-ocs-900n/> for the latest firmware updates and User Manual.

Warranty



To view the product warranty, use the following link or QR code:

<https://atlona.com/warranty/>.

Safety and Certification



CAUTION: TO REDUCE THE RISK OF ELECTRIC SHOCK DO NOT OPEN ENCLOSURE OR EXPOSE TO RAIN OR MOISTURE. NO USER-SERVICEABLE PARTS INSIDE REFER SERVICING TO QUALIFIED SERVICE PERSONNEL.



The exclamation point within an equilateral triangle is intended to alert the user to the presence of important operating and maintenance instructions in the literature accompanying the product.



The information bubble is intended to alert the user to helpful or optional operational instructions in the literature accompanying the product.

1. Read these instructions.
2. Keep these instructions.
3. Heed all warnings.
4. Follow all instructions.
5. Do not use this product near water.
6. Clean only with a dry cloth.
7. Do not block any ventilation openings. Install in accordance with the manufacturer's instructions.
8. Do not install or place this product near any heat sources such as radiators, heat registers, stoves, or other apparatus (including amplifiers) that produce heat.
9. Do not defeat the safety purpose of a polarized or grounding-type plug. A polarized plug has two blades with one wider than the other. A grounding type plug has two blades and a third grounding prong. The wide blade or the third prong are provided for your safety. If the provided plug does not fit into your outlet, consult an electrician for replacement of the obsolete outlet.
10. Protect the power cord from being walked on or pinched particularly at plugs, convenience receptacles, and the point where they exit from the product.
11. Only use attachments/accessories specified by Atlona.
12. To reduce the risk of electric shock and/or damage to this product, never handle or touch this unit or power cord if your hands are wet or damp. Do not expose this product to rain or moisture.
13. Unplug this product during lightning storms or when unused for long periods of time.
14. Refer all servicing to qualified service personnel. Servicing is required when the product has been damaged in any way, such as power-supply cord or plug is damaged, liquid has been spilled or objects have fallen into the product, the product has been exposed to rain or moisture, does not operate normally, or has been dropped.



FCC Compliance

FCC Compliance and Advisory Statement: This hardware device complies with Part 15 of the FCC rules. Operation is subject to the following two conditions: 1) this device may not cause harmful interference, and 2) this device must accept any interference received including interference that may cause undesired operation. This equipment has been tested and found to comply with the limits for a Class A digital device, pursuant to Part 15 of the FCC Rules. These limits are designed to provide reasonable protection against harmful interference in a commercial installation. This equipment generates, uses, and can radiate radio frequency energy and, if not installed or used in accordance with the instructions, may cause harmful interference to radio communications. However there is no guarantee that interference will not occur in a particular installation. If this equipment does cause harmful interference to radio or television reception, which can be determined by turning the equipment off and on, the user is encouraged to try to correct the interference by one or more of the following measures: 1) reorient or relocate the receiving antenna; 2) increase the separation between the equipment and the receiver; 3) connect the equipment to an outlet on a circuit different from that to which the receiver is connected; 4) consult the dealer or an experienced radio/TV technician for help. Any changes or modifications not expressly approved by the party responsible for compliance could void the user's authority to operate the equipment. Where shielded interface cables have been provided with the product or specified additional components or accessories elsewhere defined to be used with the installation of the product, they must be used in order to ensure compliance with FCC regulations.

Copyright, Trademark, and Registration

© 2024 Atlona Inc. All rights reserved. "Atlona" and the Atlona logo are registered trademarks of Atlona Inc. Pricing, specifications and availability subject to change without notice. Actual products, product images, and online product images may vary from images shown here.

All other trademark(s), copyright(s), and registered technologies mentioned in this document are the properties of their respective owner(s).

Table of Contents

Introduction	6
Features	6
Package Contents	6
Panel Description	7
Installation	8
Connection Instructions	8
Coverage Pattern Diagrams	9
Removal Instructions	10
Connection Diagram	11
Device Operation	12
Logging in to the Web Server	12
Login Registration	12
Logging in after registration	13
Setting a Static IP Address	14
Using DHCP to assign an IP address	15
Using Transport Layer Security (TLS)	16
Changing the Hostname	17
Resetting Login Credentials	18
Setting Device Information	19
Working with Configuration Files	20
Saving Configuration Files	20
Uploading Configuration Files	20
Resetting the AT-OCS-900N	21
Using the Web Server	21
Using the Hardware Reset Button	21
Restarting the AT-OCS-900N	22
Configuring the Sensor	23
Motion Sensor Events	23
Setting the LED Color	24
Ambient Light Sensor	26
Ambient Temperature Sensor	27
Using MQTT	28
Overview	28
Configuring MQTT	29
Configuration and Management Interfaces	32
Web Server	32
First Time Registration page	32
Login page	33
Dashboard page	34
Sensors Page	38
Protocols Page	41
Network Page	46
User Page	48
System Page	49
Appendix	51
Updating the Firmware	51
Using the Web Server	51
Integration with Velocity	53
Driver Configuration	53
Device Variables	55
Integration with AT-OME-MS52W / AT-UHD-SW-510W	56
Integration with AT-OME-MS42	58
Specifications	60

Introduction

The Atlona **AT-OCS-900N** is a network-enabled multi-function sensor designed for use in a wide variety of AV automation applications. This ceiling mounted sensor uses passive infrared (PIR) technology to detect occupancy in the coverage area. The OCS-900N utilizes an IP network to communicate with select Atlona products and the Velocity™ system to automatically control AV components based on whether the space is occupied. It comes with two lenses that cover approximately 900 or 2,000 square feet depending on ceiling height. A blinder insert is included that limits the sensor's field of view, preventing detection in unwanted areas such as doorways or windows with heavy cross traffic. Installation is simplified by Power over Ethernet (PoE), that provides both communications and power over a single cable as well as spring-loaded clamps that secure the sensor to a ceiling tile.

In addition to occupancy, the OCS-900N also captures temperature and ambient light level information. Its open standard design allows sensor information to be communicated to third-party ventilation, lighting, and other systems over TCP/IP using common protocols such as UDP, TCP, WebSocket, and MQTT.

Features

- Multi-function sensor that detects occupancy, temperature, and ambient light.
- IP-enabled for communicating state information over Ethernet.
- Passive infrared (PIR) detection technology.
- Customizable detection area with standard lens covering 900 square feet and included accessory lens covering 2,000 square feet.
- 360 degrees field of view standard, or limit to 240 degrees with included blinder insert.
- Configurable LED indicators may be customized for both color and activity.
- Communicates over the network directly to the Atlona AT-WAVE-101 for automatic display control.
- Works with Velocity™ AV control systems for more complex automation applications.
- Supports network communications with third-party devices using common protocols such as UDP, TCP, WebSocket, and MQTT.
- Power over Ethernet (PoE) for remote power and network connection with a single cable.

Package Contents

- 1 x AT-OCS-900N with installed Standard Ceiling lens
- 1 x 120-degree optics shader
- 1 x High Ceiling lens
- 1 x Installation guide

Panel Description

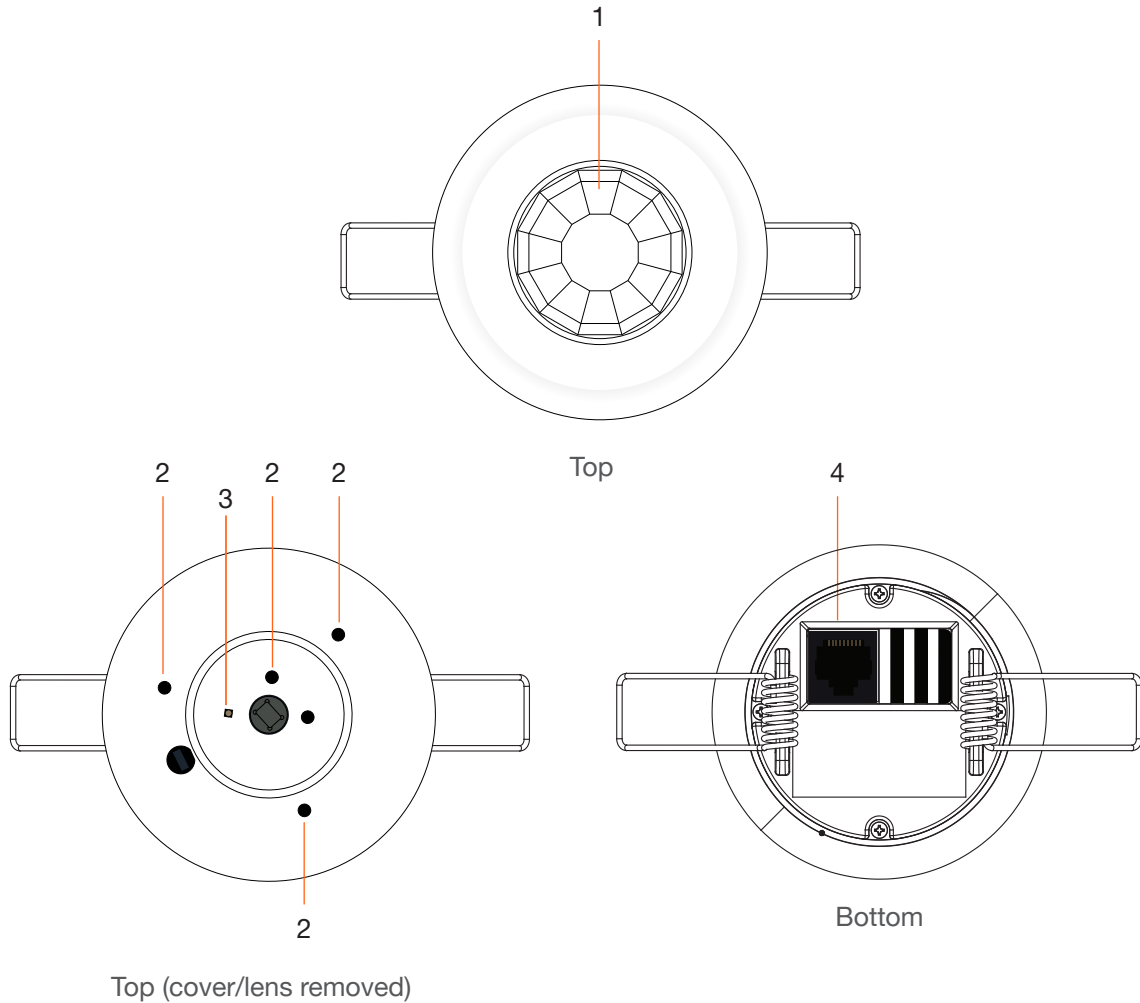

1 Fresnel Lens

Diffraction of the incoming light and directs the light to the infrared sensor.

2 LED indicators

These indicators provide lens illumination for device functionality and testing. These LED indicators can be changed to different colors, if desired. Refer to [Setting the LED Color \(page 24\)](#) for more information.

3 Factory Reset

Press and hold this button for 5 seconds to reset the AT-OCS-900N to factory-default settings. Refer to [Resetting the AT-OCS-900N \(page 21\)](#) for more information.

4 LAN port

Connect an Ethernet cable from this port to the Local Area Network.

Installation

Connection Instructions



IMPORTANT: This product is designed to be installed by instructed or skilled person(s) only. Also, do not touch or apply pressure to the IR sensor. Doing so may damage or break the IR sensor.

1. Determine the coverage area required. Refer to [Coverage Pattern Diagrams \(page 9\)](#) for more information.
2. Connect an Ethernet cable from the **LAN** port to the Local Area Network.

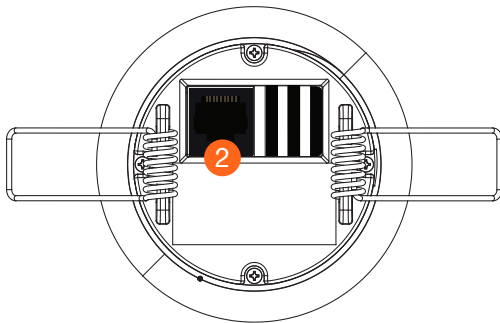

3. In a pre-drilled 2.5" hole, fold the wing clips towards the center of the AT-OCS-900N. The recommended mounting hold diameter is 2.5" and should not exceed a diameter of 2.90". Refer to [Figure 1.1](#) for dimensions of the AT-OCS-900N.
4. Insert the device into the ceiling tile and release clips. The wing clips will return to the down position, securing the unit in place.

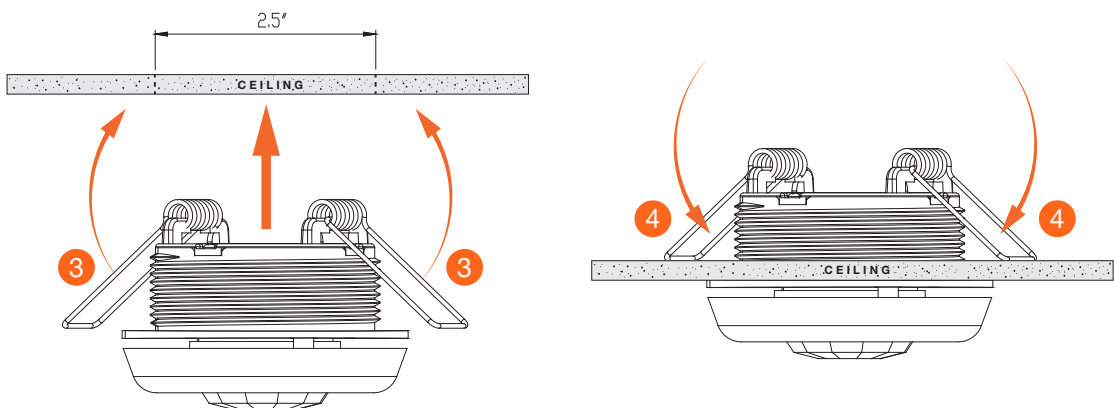
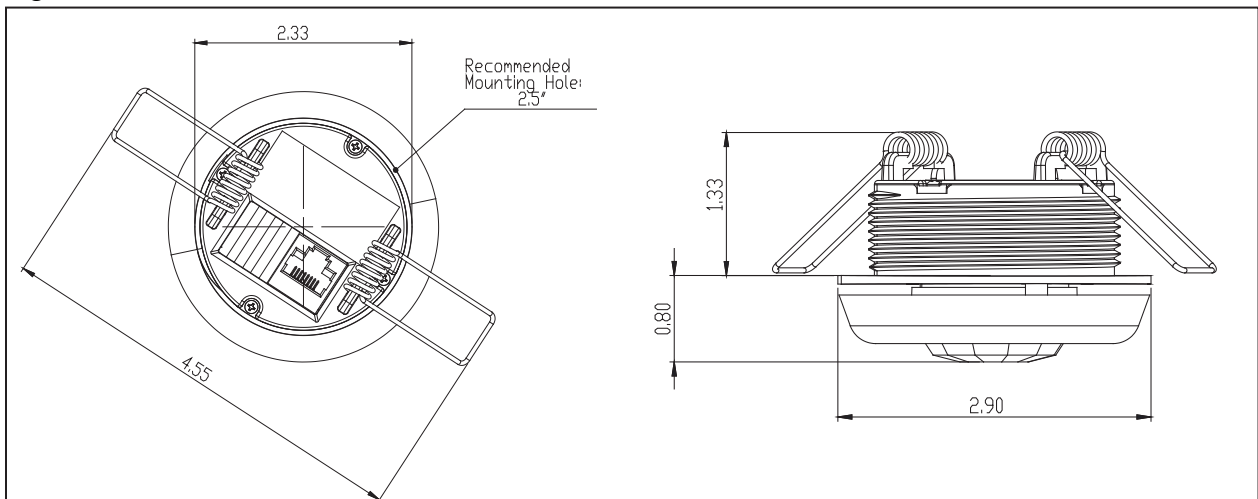

Figure 1.1



Coverage Pattern Diagrams

The AT-OCS-900N includes a factory-installed Standard Ceiling lens. The Standard Ceiling lens can be replaced with the included High Ceiling lens, depending on the size of the room. Refer to the diagrams below for coverage area.

Standard Ceiling Coverage

Top View

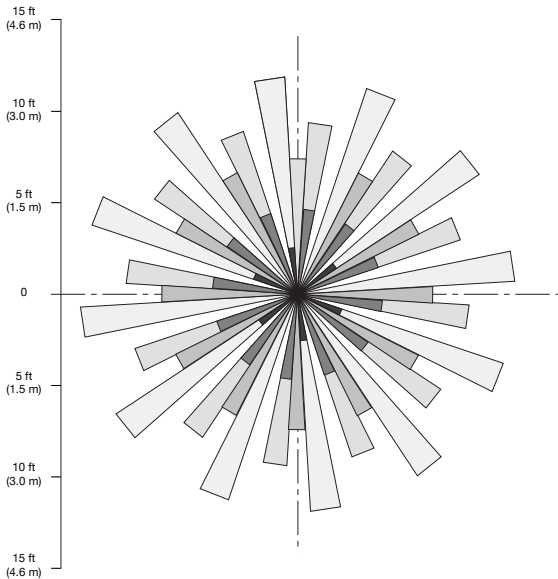

High Ceiling Coverage

Top View

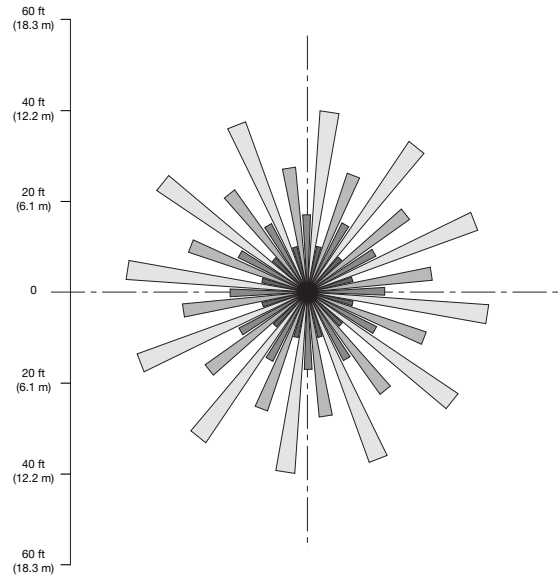

Side View

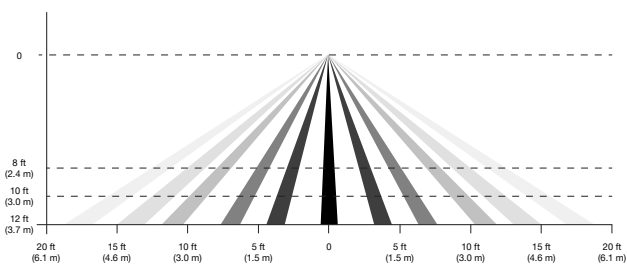

Side View

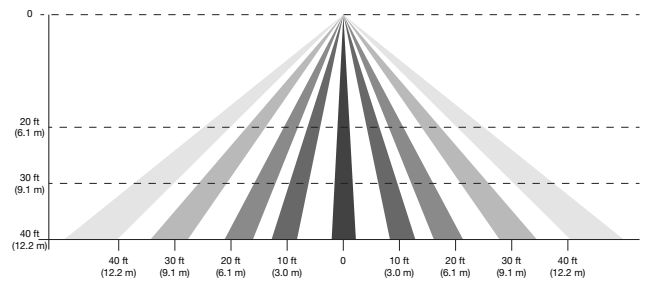

Removal Instructions

The AT-OCS-900N can be easily removed if necessary. Refer to the instructions below.

1. Gently grasp the AT-OCS-900N by the lens cover and slowly pull down with steady pressure.
2. As the unit pulled down, the wing clips will fold up, allowing the unit to be removed from the mounting hole.
3. Once the removed, the wing clips will return to their normal position.
4. Disconnect the Ethernet cable from the **LAN** port.

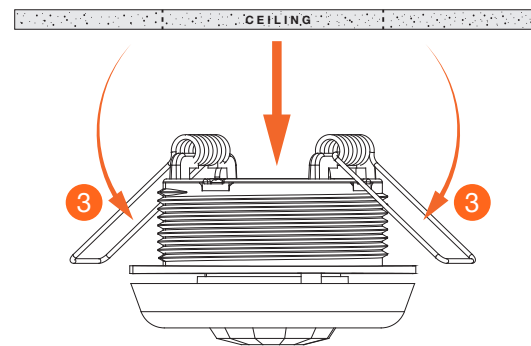
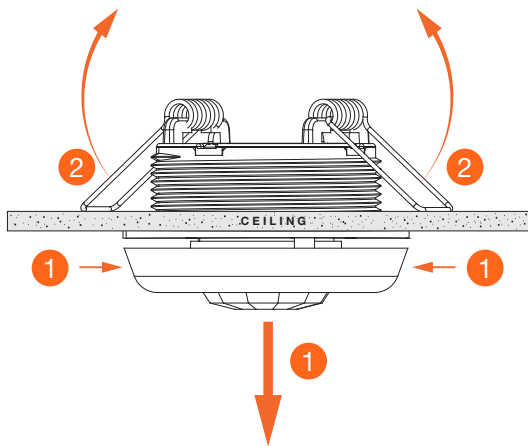

Connection Diagram

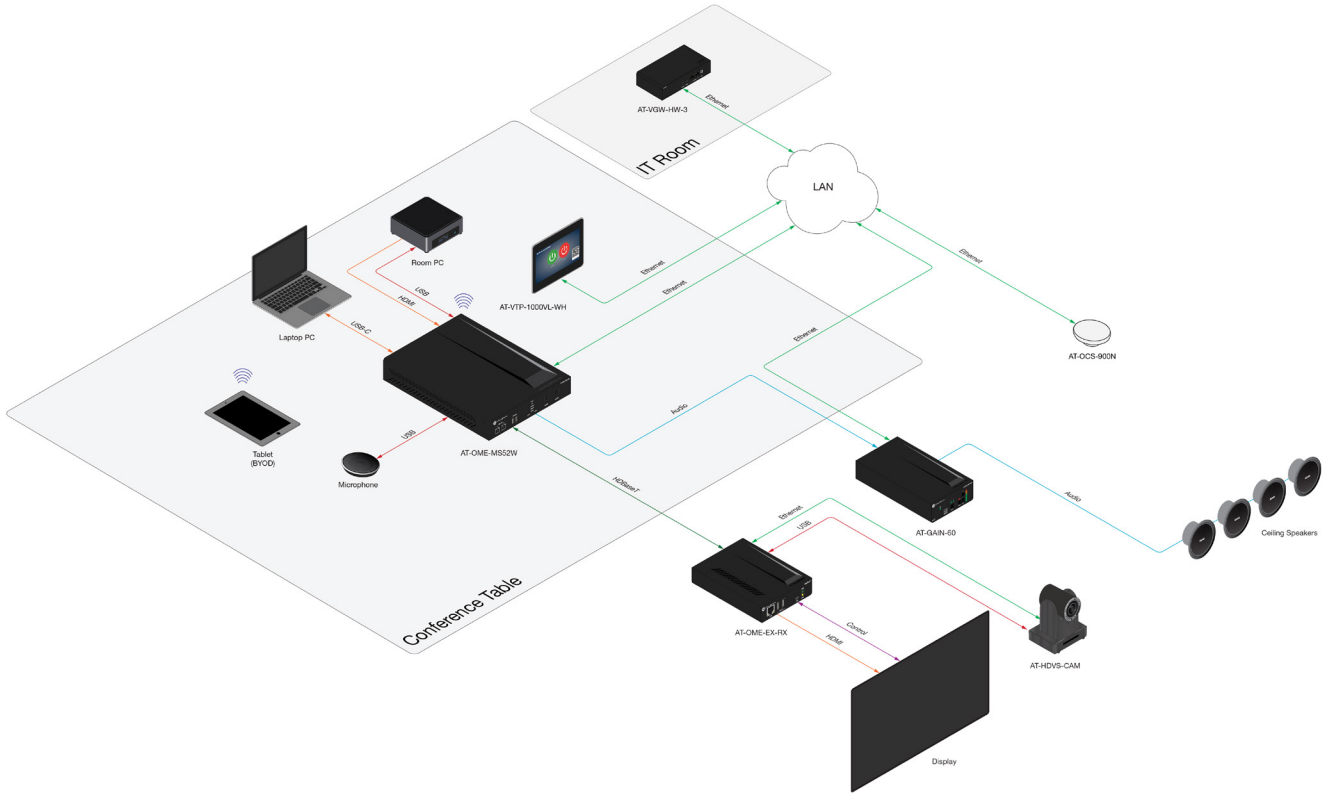

Device Operation

Logging in to the Web Server

Most of the AT-OCS-900N operation is handled through the built-in web server. In order to access the web server, the IP address of the unit must be known.

Login Registration

1. Launch the desired web browser and enter the IP address of the AT-OCS-900N in the address bar.
2. The AT-OCS-900N **Login Registration** page will be displayed.

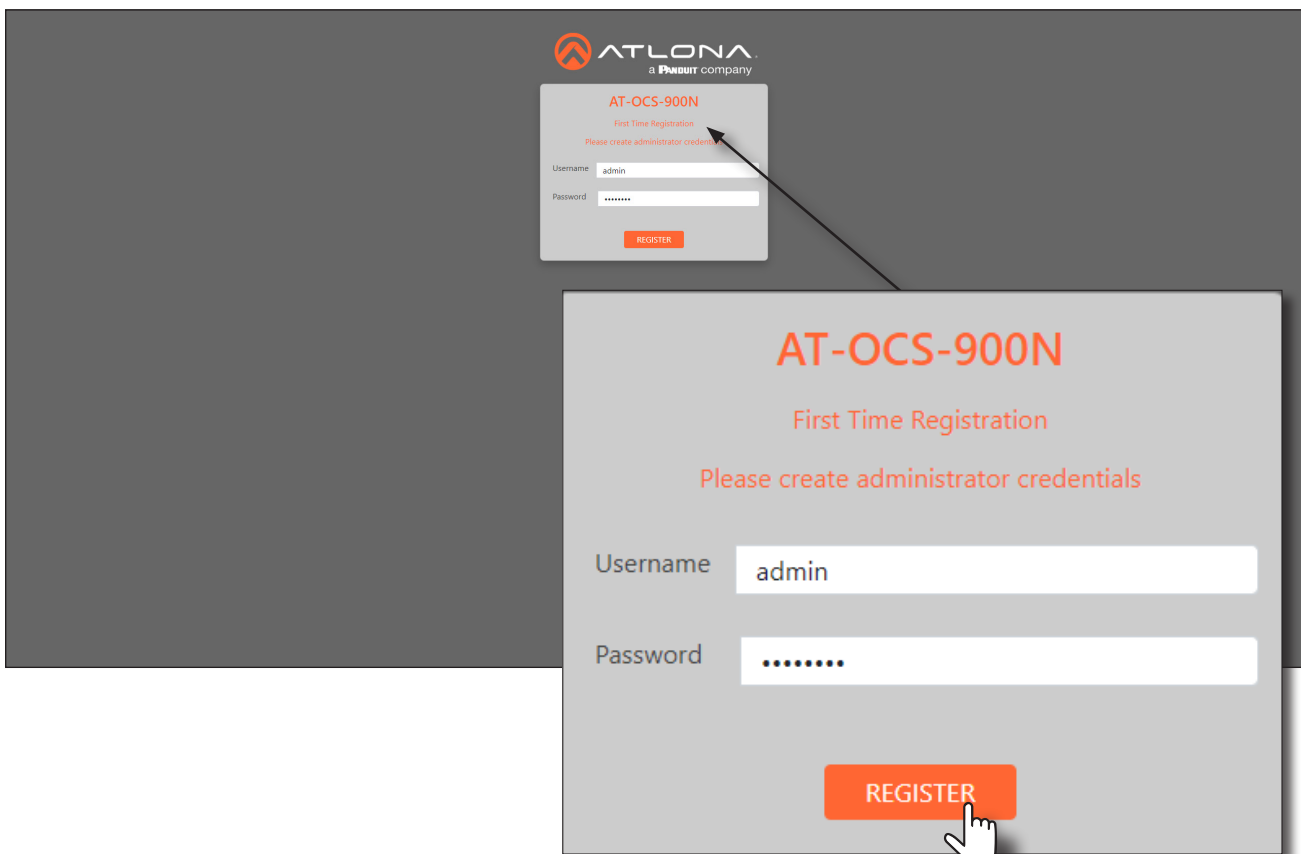

3. Enter the desired username in the **Username** field. In the example above, the username `admin` is used.
4. Enter the desired password in the **Password** field.



IMPORTANT: Both the username and password must be 5 - 16 characters in length. Alphanumeric characters and symbols are permitted. Note that the **Password** field will be masked when entering the password.

5. Verify the password by entering it in the **Confirm** field.
6. Click the **Register** button.
7. The **Dashboard** screen will be displayed. Refer to [Dashboard page \(page 34\)](#) for more information.
8. The login registration process is complete.

Logging in after registration

1. Launch the desired web browser and enter the IP address of the AT-OCS-900N in the address bar.
2. Enter the correct username and password in the respective fields.
3. Click the **Login** button.



AT-OCS-900N

Sign In

Username

Password

LOGIN

4. The **Dashboard** page will be displayed. Refer to [Dashboard page \(page 34\)](#) for more information.

Setting a Static IP Address

1. Open the desired web browser and enter the IP address of the AT-OCS-900N.
2. Login using the required credentials.
3. Click **Network** on the side menu bar.

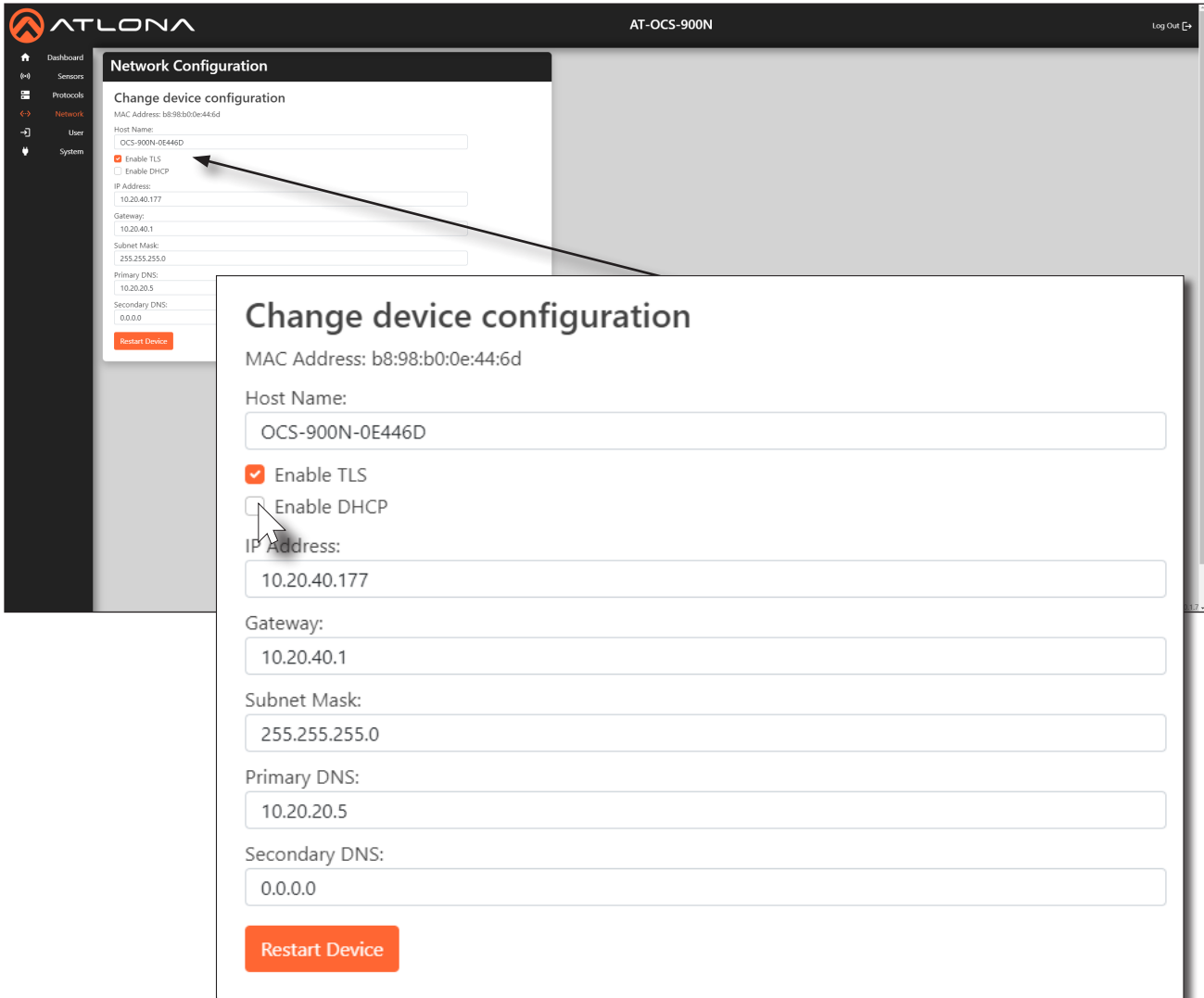

The screenshot shows the ATLONA web interface for an AT-OCS-900N device. The 'Network Configuration' section is active, and a modal window titled 'Change device configuration' is displayed. The modal contains the following fields and options:

- MAC Address: b8:98:b0:0e:44:6d
- Host Name: OCS-900N-0E446D
- Enable TLS
- Enable DHCP
- IP Address: 10.20.40.177
- Gateway: 10.20.40.1
- Subnet Mask: 255.255.255.0
- Primary DNS: 10.20.20.5
- Secondary DNS: 0.0.0.0
- Restart Device button

4. Locate **Enable DHCP**. If there is a check mark in this box, click to remove the check mark. This will disable DHCP and provide the option to specify a static IP address.
5. Enter the desired address in the **IP Address** field. Also enter the required information in the **Gateway** and **Subnet Mask** fields.
6. Enter DNS information in the **Primary DNS** and **Secondary DNS** fields, if required.
7. Click the **Restart Device** button to save the changes and restart the unit using the static IP address.

Using DHCP to assign an IP address

The AT-OCS-900N is shipped with DHCP enabled. Once connected to a network, the DHCP server (if available), will automatically assign an IP address to the unit. To switch from a static IP address to a dynamically-assigned IP address, DHCP must be enabled on the AT-OCS-900N.

1. Open the desired web browser and enter the IP address of the AT-OCS-900N.
2. Login using the required credentials.
3. Click **Network** on the side menu bar.
4. Click the **Enable DHCP** checkbox. If the box is checked, then the AT-OCS-900N will obtain an IP address from a DHCP server.



NOTE: When **Enable DHCP** is active, none of the IP address fields can be changed.

Change device configuration

MAC Address: b8:98:b0:0e:44:6d

Host Name:

Enable TLS
 Enable DHCP

IP Address:

Gateway:

Subnet Mask:

Primary DNS:

Secondary DNS:

5. Click the **Restart Device** button to save changes and restart the unit.

Using Transport Layer Security (TLS)

The AT-OCS-900N provides Transport Layer Security (TLS) for added communication security over a non-secure network. TLS is enabled by default on the AT-OCS-900N. However, this feature can be enabled or disabled. Enabling TLS is required if using MQTT over TLS.

1. Open the desired web browser and enter the IP address of the AT-OCS-900N.
2. Login using the required credentials.
3. Click **Network** on the side menu bar.
4. Locate the **Enable TLS** checkbox. When checked, TLS is enabled. Uncheck this box to disable TLS.

Change device configuration

MAC Address: b8:98:b0:0e:44:6d

Host Name:

Enable TLS
 Enable DHCP

IP Address:

Gateway:

Subnet Mask:

Primary DNS:

Secondary DNS:

5. Click the **Restart Device** button to save changes and restart the unit.

Changing the Hostname

By default, the host name of the AT-OCS-900N is set to the following: OCS-900N-[id], where [id] is the last six digits of the MAC address. However, the host name can be changed to a more recognizable identifier. The hostname must conform to the NetBIOS specification.

1. Open the desired web browser and enter the IP address of the AT-OCS-900N.
2. Login using the required credentials.
3. Click **Network** on the side menu bar.
4. Click in the **Host Name** field and enter the desired host name.

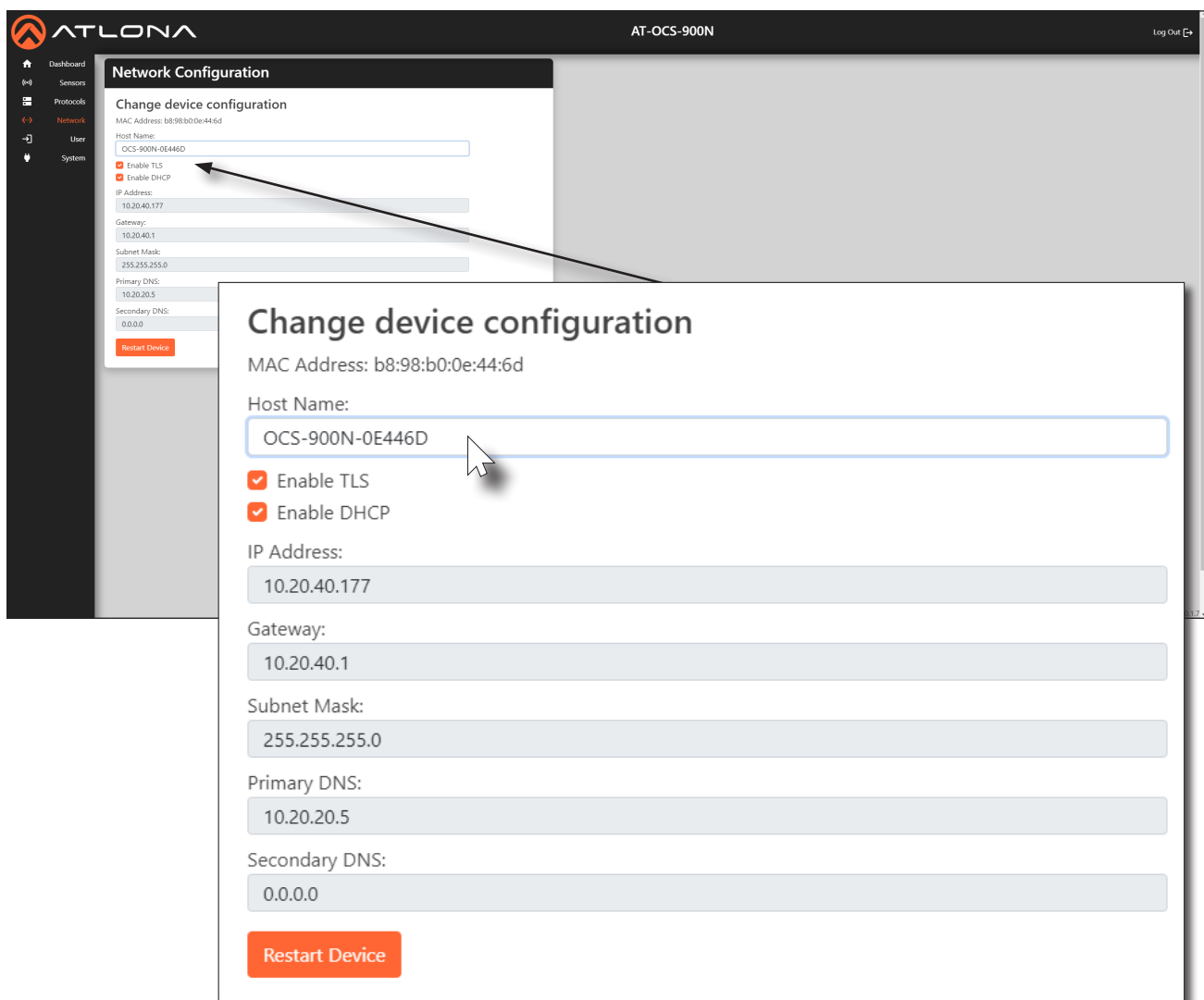

5. Click the **Restart Device** button to save changes and restart the unit.

Resetting Login Credentials

It is recommend to change the login credentials often to restrict access to the AT-OCS-900N by authorized users. Both the user name and password can be changed.

1. Open the desired web browser and enter the IP address of the AT-OCS-900N.
2. Login using the required credentials.
3. Click **User** in the side menu bar.

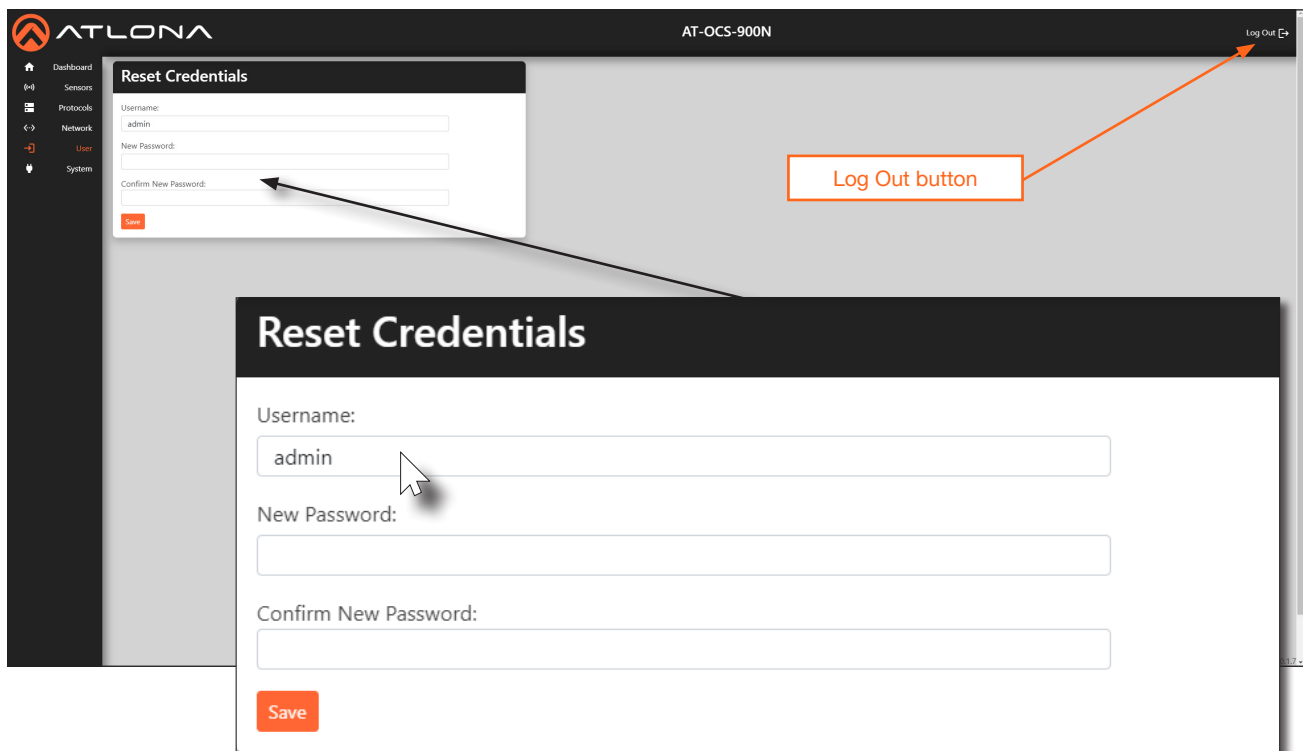

4. In the **Username** field, enter the desired user name.
5. In the **New Password** field, enter the desired password.



NOTE: Both the user name and password must be 5 - 16 characters in length, and can be any combination of letters, numbers, and symbols. Spaces are not permitted.

6. Click the **Save** button to commit changes.
7. Click the **Log Out** button in the upper-right corner of the web server, then log in using the new credentials.

Setting Device Information

The AT-OCS-900N can be assigned a name and location for reference. This information is optional, but can be useful to identify multiple AT-OCS-900N units. Name and location information will be displayed under the **Dashboard** menu.

1. Open the desired web browser and enter the IP address of the AT-OCS-900N.
2. Login using the required credentials.
3. Click **System** in the side menu bar and locate the **System Settings** window group.

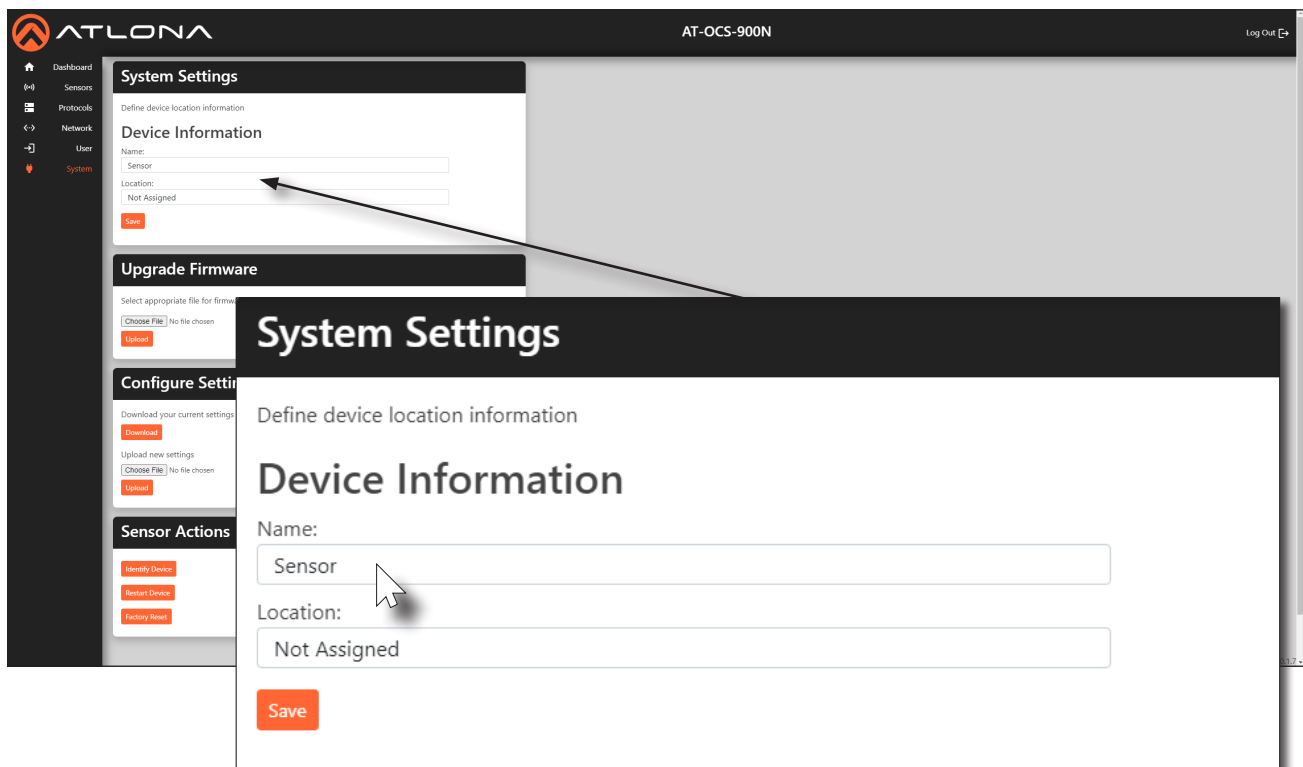

4. In the **Name** field, enter the desired name of the AT-OCS-900N.
5. In the **Location** field, provide a description of where the AT-OCS-900N is installed.
6. Click the **Save** button to commit changes.

Working with Configuration Files

AT-OCS-900N settings can be saved to or loaded from a local file. It is recommended to save the device settings, once the unit is properly configured. Configuration files are stored in `.json` format.

Saving Configuration Files

1. Open the desired web browser and enter the IP address of the AT-OCS-900N.
2. Login using the required credentials.
3. Click **System** in the side menu bar.
4. Locate the **Configure Settings** window group and click the **Download** button.

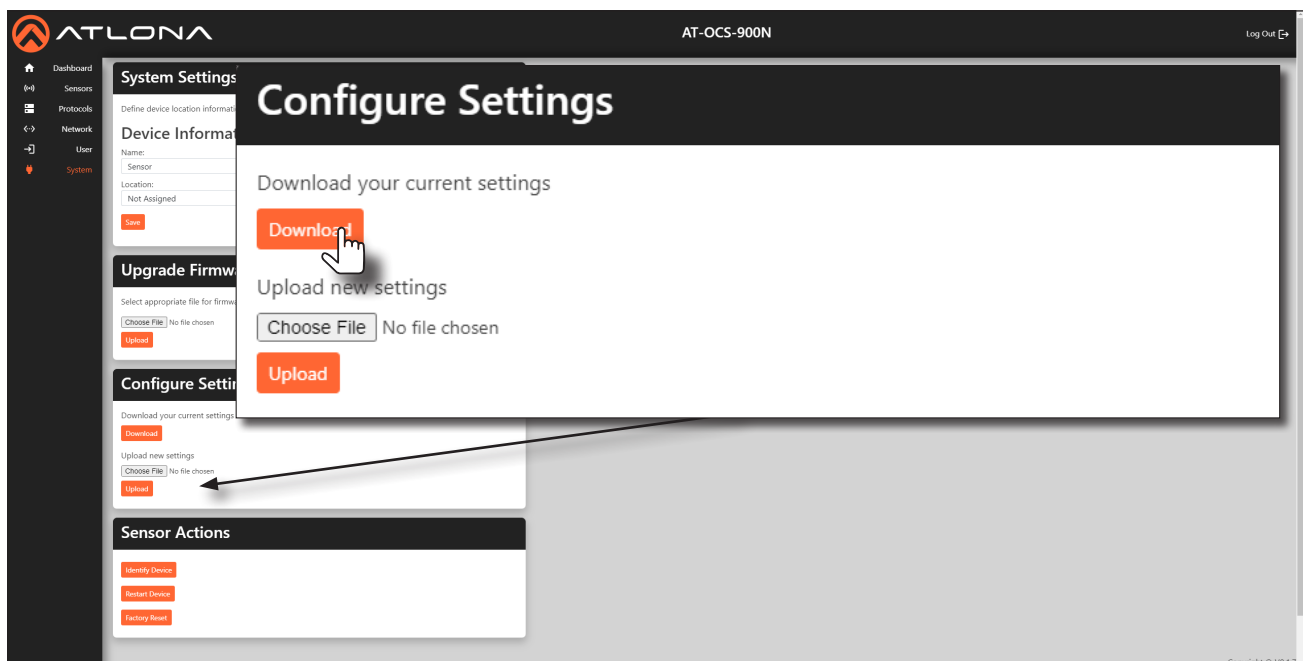

5. The **Save As** window dialog will be displayed.
6. Select the desired location to store the configuration file and click the **Save** button.
7. Enter the name of the file in the **Filename** field. The default filename is `config.json`.

Uploading Configuration Files

1. Follow steps 1 - 3 above.
2. Locate the **Configure Settings** window group and click the **Choose File** button.
3. The **Open** dialog will be displayed.
4. Select the desired configuration file and click **Open**.
5. Click the **Upload** button to upload the selected file to the AT-OCS-900N.

Resetting the AT-OCS-900N

When the AT-OCS-900N is reset, the unit will be set to factory-default settings. Before performing a reset, it is recommended to save the current settings to an external file. Refer to [Working with Configuration Files \(page 20\)](#) for more information.



IMPORTANT: Resetting the AT-OCS-900N will restore the unit to factory settings. All settings will be lost!

Using the Web Server

1. Open the desired web browser and enter the IP address of the AT-OCS-900N.
2. Login using the required credentials.
3. Click **System** in the side menu bar.
4. Locate the **Sensor Actions** window group and click the **Factory Reset** button.

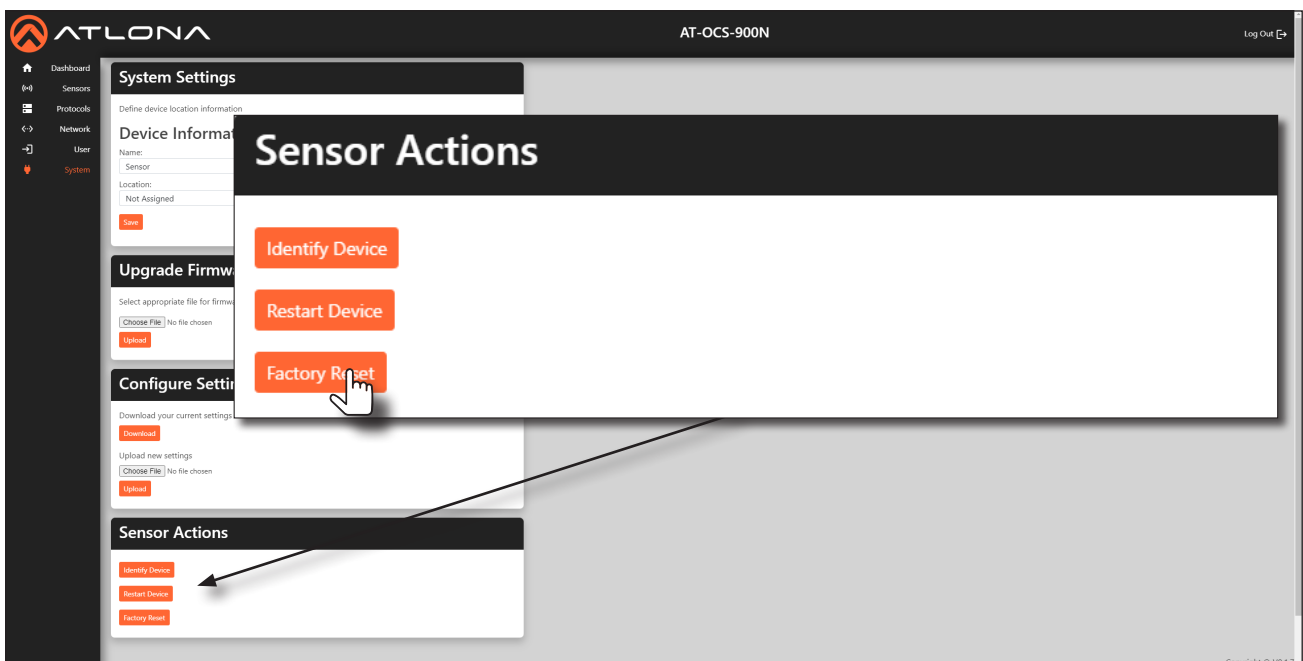

Using the Hardware Reset Button

If access to the web server is not available, the AT-OCS-900N provides a reset button on the unit.

1. Remove the lens cap by rotating it counterclockwise.
2. Locate the square-shaped **Factory Reset** button, near the center of the unit.
3. Press and hold the button for 5 seconds to factory-reset the unit.
4. Replace the lens cap on the unit by turning clockwise.

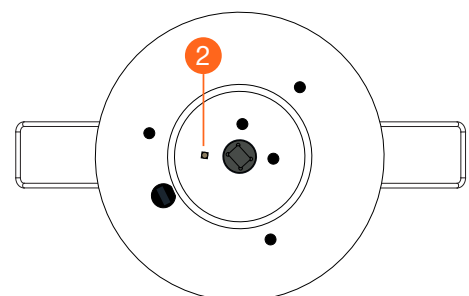

Restarting the AT-OCS-900N

The AT-OCS-900N can be restarted without losing any settings. Following the procedure below.

1. Open the desired web browser and enter the IP address of the AT-OCS-900N.
2. Login using the required credentials.
3. Click **System** in the side menu bar.
4. Locate the **Sensor Actions** window group and click the **Restart Device** button.

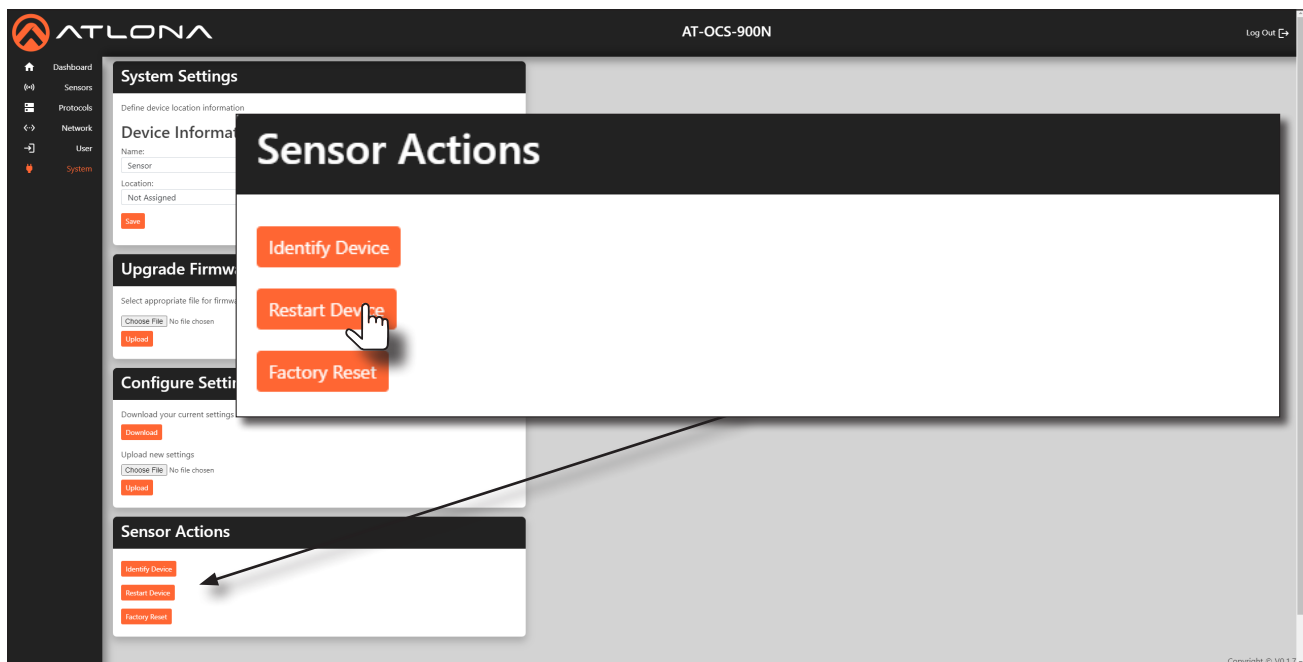

Configuring the Sensor

This section covers the sensor configuration and LED indicator color modification.

Motion Sensor Events

1. Open the desired web browser and enter the IP address of the AT-OCS-900N.
2. Login using the required credentials.
3. Click **Sensors** in the side menu bar.
4. Locate the **Motion Sensors** window group.

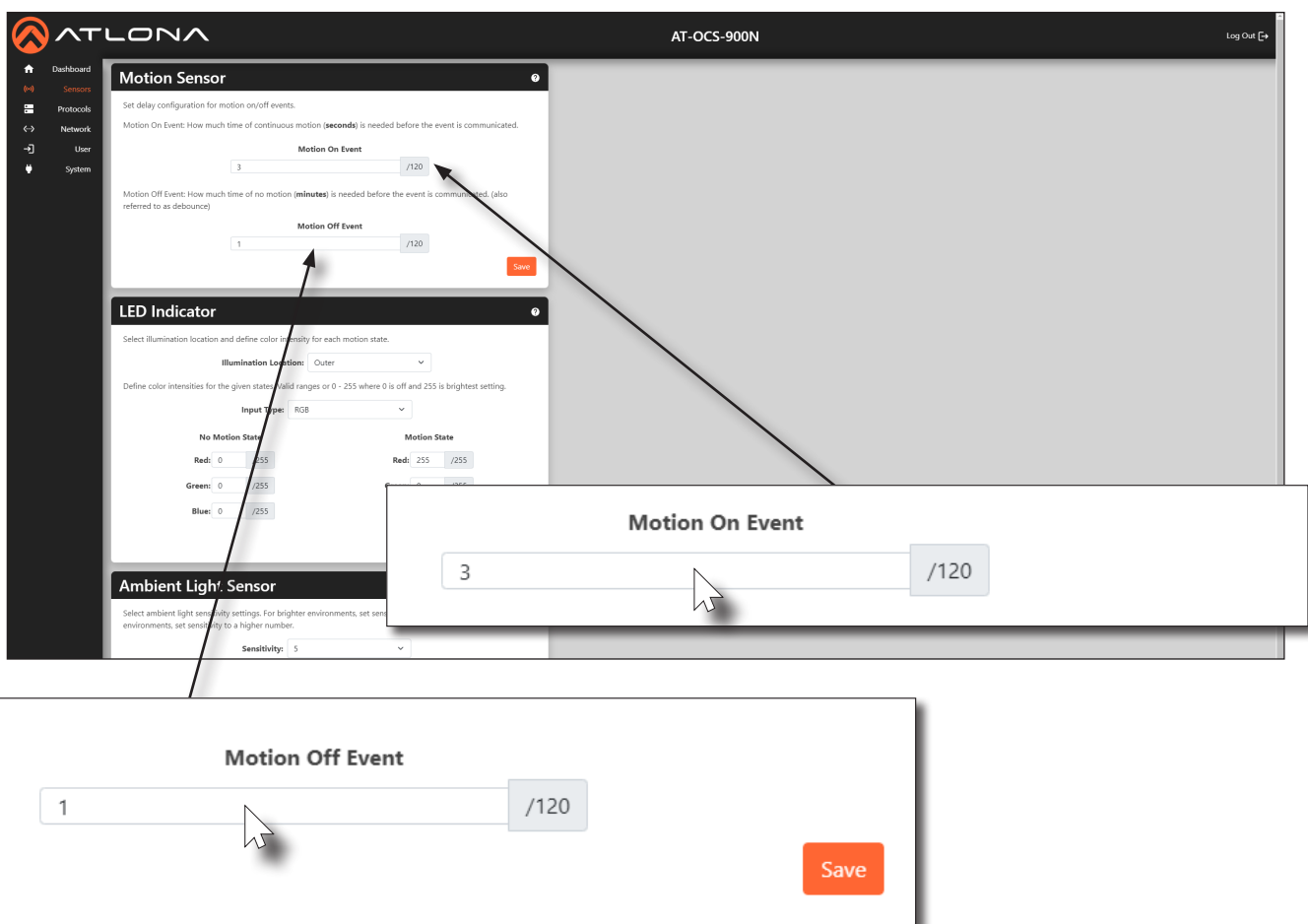

5. In the **Motion On Event** field, enter the period of continuous motion (in seconds) that is required before the motion-on event is triggered.
6. In the **Motion Off Event** field, enter the delay (in minutes) in which there is no motion, before the motion-off event is triggered.
7. Click the **Save** button, in the lower-right corner of the **Motion Sensor** window group, to commit changes.

Setting the LED Color

The AT-OCS-900N has a single center and three outer LED indicators, as shown below. Removing the lens cap will expose these LED indicators. The color of each of these LED indicators can be changed to any color. Note that when these LED indicators are triggered, either the center or outer indicators will be triggered. Both center and outer LED indicators cannot be triggered at the same time.

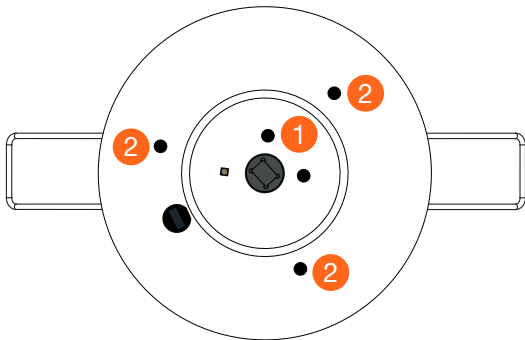

- (1) Center LED
- (2) Outer LED

1. Open the desired web browser and enter the IP address of the AT-OCS-900N.
2. Login using the required credentials.
3. Click **Sensors** in the side menu bar.
4. Locate the **LED Indicator** window group.

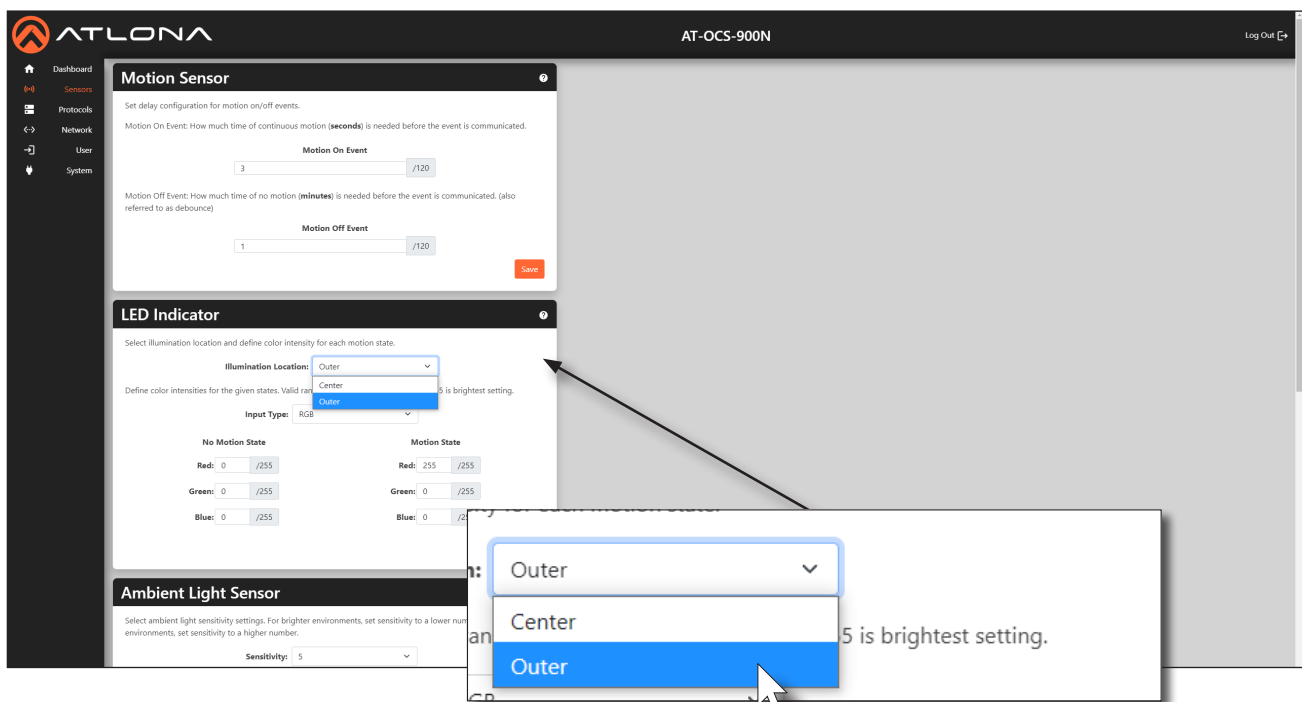

5. Click the **Illumination Location** drop-down list to select either **Center** or **Outer**.

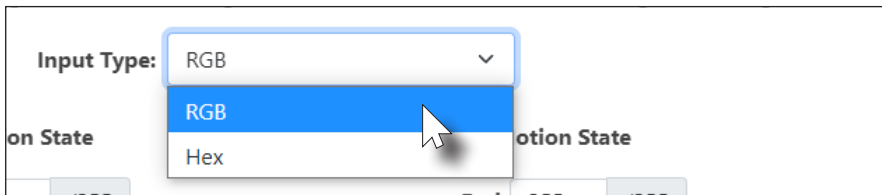

- Click the **Input Type** drop-down list and select **RGB** or **Hex**. If **RGB** is selected, the LED color will be represented by Red, Blue, Green (RGB) values. The valid range for each component is 0 to 255. If **Hex** is selected, then the LED color will be represented by a singular hexadecimal value in the form of #xxxxxxx. Valid range is #000000 to #FFFFFF.

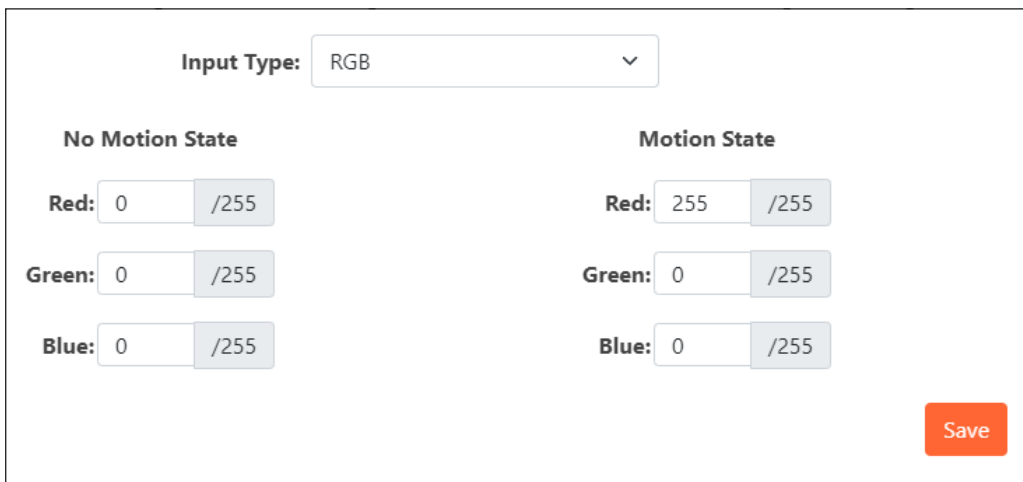

- Enter the value(s) for both the **No Motion State** and **Motion State**, depending on the color format that was selected in the previous step.
- Click the **Save** button to commit changes.

Ambient Light Sensor

This section provides adjustment for ambient light sensitivity.

1. Open the desired web browser and enter the IP address of the AT-OCS-900N.
2. Login using the required credentials.
3. Click **Sensors** in the side menu bar.
4. Locate the **Ambient Light Sensor** window group.

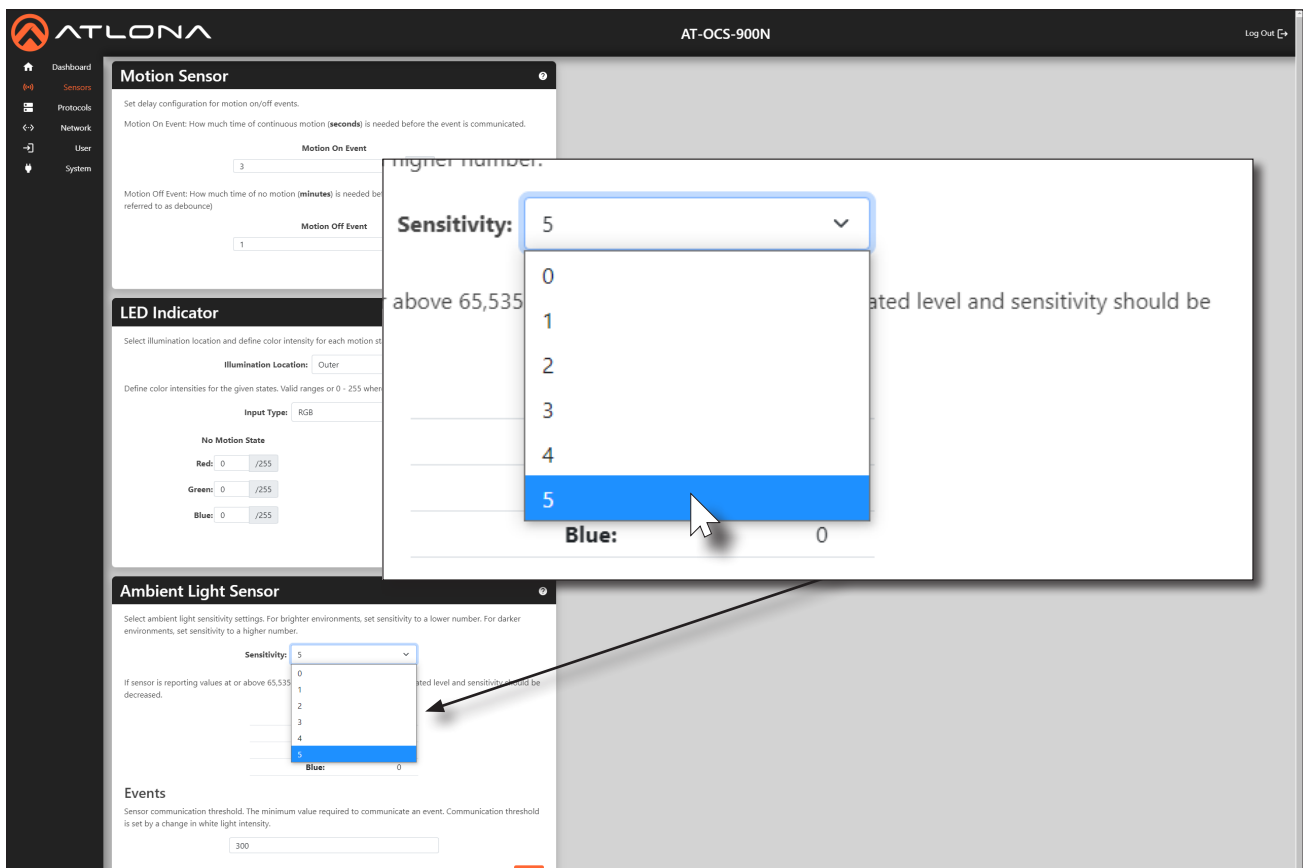

5. Click the **Sensitivity** drop-down list and select the desired setting. For brighter environments, set the sensitivity setting to a lower value. For darker environments, set the sensitivity setting to a higher value.
6. Under **Events**, enter the sensor communication threshold in the provided field. This value will be the minimum value required to trigger an event.
7. Click the **Save** button to commit changes.

Ambient Temperature Sensor

This section provides adjustment for ambient light sensitivity.

1. Open the desired web browser and enter the IP address of the AT-OCS-900N.
2. Login using the required credentials.
3. Click **Sensors** in the side menu bar.
4. Locate the **Ambient Temperature Sensor** window group. The current ambient temperature will be displayed.

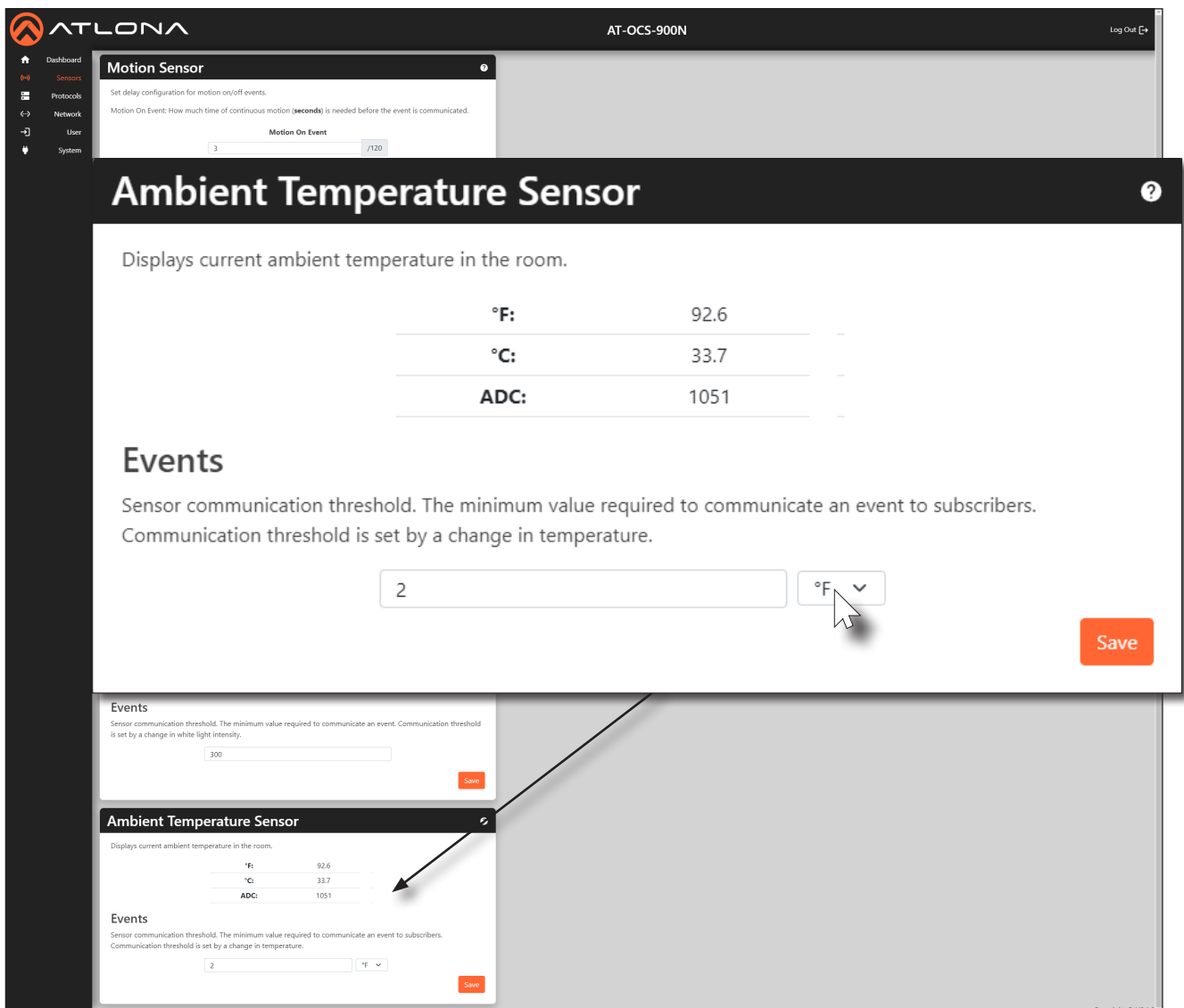

The screenshot shows the AT-OCS-900N web interface. The main content area is titled "Ambient Temperature Sensor" and includes a description: "Displays current ambient temperature in the room." Below this, a table shows the current readings:

°F:	92.6
°C:	33.7
ADC:	1051

Below the table is the "Events" section, which states: "Sensor communication threshold. The minimum value required to communicate an event to subscribers. Communication threshold is set by a change in temperature." A text input field contains the value "2", and a dropdown menu is set to "°F". A "Save" button is located at the bottom right of this section. A smaller inset window at the bottom shows the same configuration page with a mouse cursor pointing to the dropdown menu.

5. In the provided field, enter the change in temperature when an event should be triggered. Click the drop-down list next to this field to select either **°F** or **°C**.
6. Click the **Save** button to commit changes.

Using MQTT

Overview

The term *Internet of Things (IoT)* is used to describe devices that connect and exchange data with other devices and systems over the Internet or other local networks. However, in order for each device to be able to communicate with one another, a communication protocol must be used. One such protocol is Message Queuing Telemetry Transport (MQTT) and is used by the AT-OCS-900N to communicate with other devices. MQTT is a TCP-based “subscribe and publish” protocol. A detailed explanation of the MQTT protocol is beyond the scope of this manual. However, the illustration below shows the basic architecture.

The MQTT architecture consists of a *broker* (server) and one or more *clients*. For example, in the Figure 1.2, the AT-OCS-900N is connected to a LAN, along with two other clients and a broker. Client A and Client B will now subscribe to a particular *topic*, which is then published to the broker. A topic can be anything, but for this illustration, Client A and Client B will subscribe to the “temperature” topic.

Figure 1.2

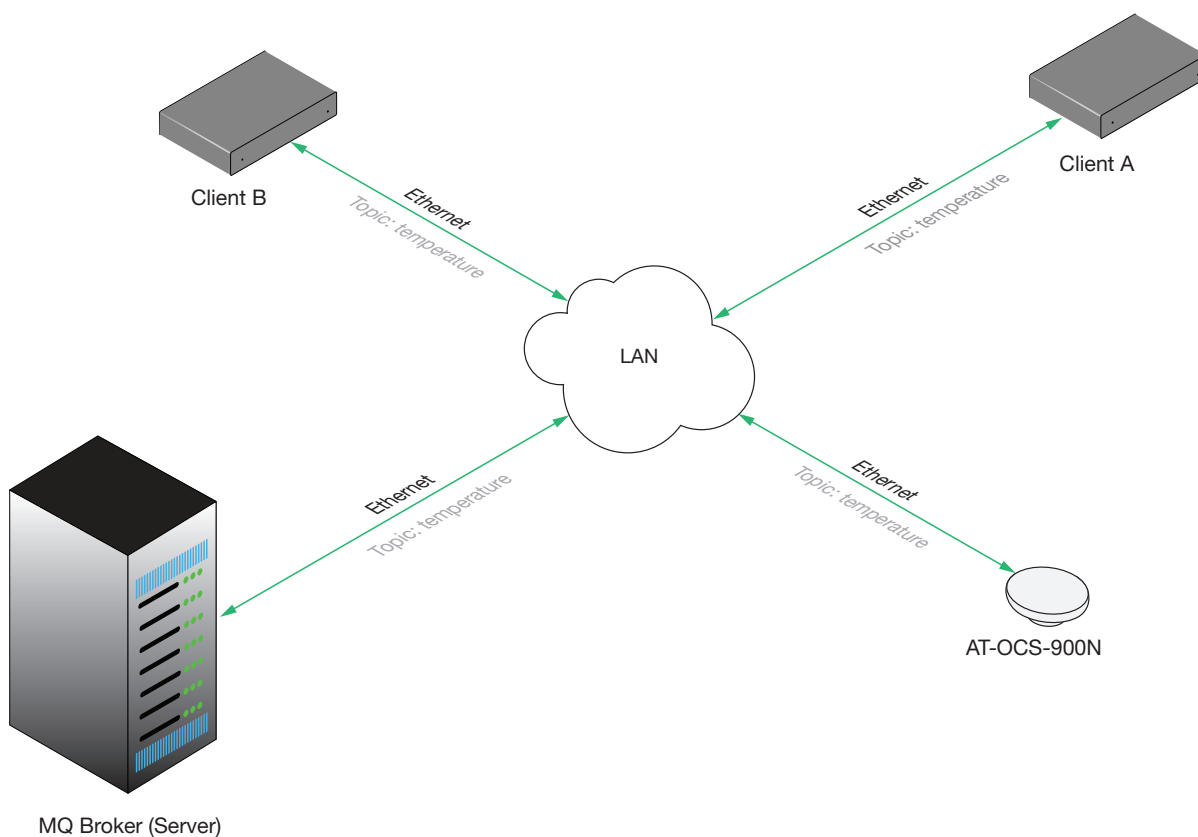

When the AT-OCS-900N updates the topic of “temperature”, it will publish this information to the topic of “temperature” to the broker. Since both Client A and Client B are subscribing to the topic of “temperature”, both Client A and Client B will receive the updated temperature information.

Configuring MQTT

This section provides instructions on configuring MQTT.

1. Open the desired web browser and enter the IP address of the AT-OCS-900N.
2. Login using the required credentials.
3. Click **Protocols** in the side menu bar and locate the **MQTT Client** window group.
4. Click the **Enable MQTT** toggle switch to enable the feature. When enabled, this toggle switch will be green.
5. Under **Connection Settings**, do the following:
 - a. Enter the address of the broker in the **Broker** field.
 - b. Enter the port number in the Port field. The default non-secure port is 1883, as shown below. However, if using MQTT over TLS, then port 8883 must be used.

NOTE: If using MQTT over TLS, then Transport Layer Security (TLS) must be enabled. To enable TLS, click the **Network** menu and click the checkbox for **Enable TLS**. Refer to [Using Transport Layer Security \(TLS\) \(page 16\)](#) for more information.

- c. Enter the client name in the **Client-ID** field. This field is required in order for the broker to store session information for a client.
- d. Enter the keep alive value in the **Keep Alive** field. This value is used to make sure that the connection between the broker and the client are open and that both devices are aware of being connected. Setting this value to 0 (zero) will disable the keep alive mechanism.
- e. Click the **Clean Session** checkbox to enable to disable a clean (non-persistent) session. When enabled, this box will be checked.

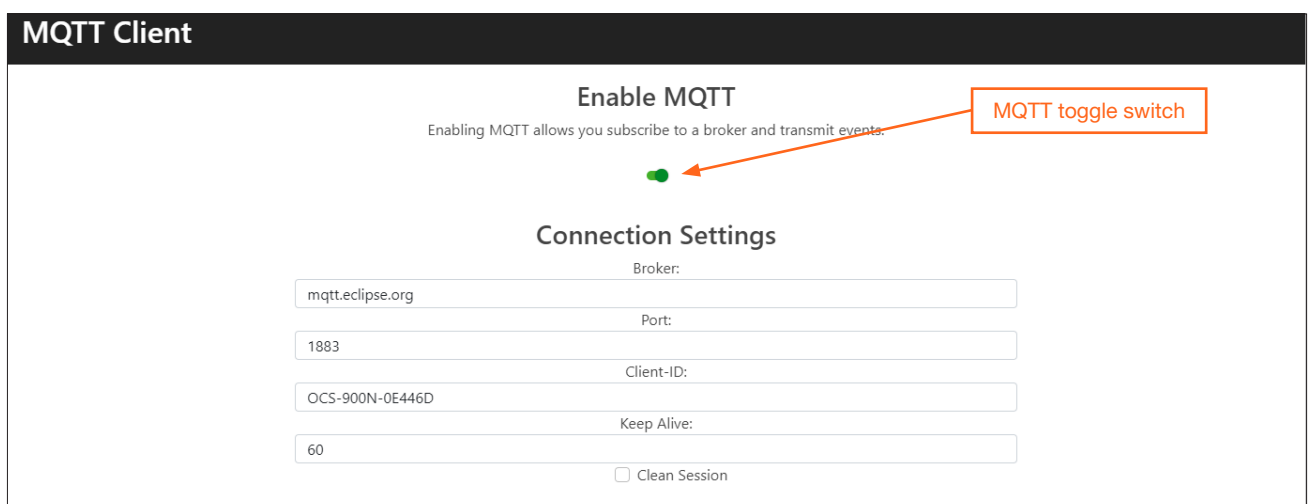

MQTT Client

Enable MQTT
Enabling MQTT allows you subscribe to a broker and transmit events.

MQTT toggle switch

Connection Settings

Broker: mqtt.eclipse.org

Port: 1883

Client-ID: OCS-900N-0E446D

Keep Alive: 60

Clean Session

When **Clean Session** is enabled, the broker does not store subscription information or any undelivered messages for the client device. All information is purged from any previous *persistent connection*. This mode should be used when the client only publishes messages.

Clean Session can also be disabled (referred to as a *persistent connection* or *durable connection*). In this mode, the broker will store both subscription and undelivered messages for the client.

NOTE: All messages are deleted from the broker once they have been delivered to the client.

Authentication Settings

Username:

Password:

Authentication

6. Under **Authentication Settings** do the following:

- a. Enter the required information in the **Username** and **Password** fields. When a client connects to a broker, both the user name and password are included in the `CONNECT` message for authentication purposes. It should be noted that authentication is optional and only required if the broker requires authentication.
- b. To enable authentication, click the **Authentication** checkbox. When a checkmark is in this box, the feature is enabled.



IMPORTANT: Authentication credentials are not automatically encrypted when transmitted to the broker, making the information vulnerable to a MITM attack. It is highly recommended to use Transport Layer Security (TLS) when connecting to a broker. Refer to [Using Transport Layer Security \(TLS\) \(page 16\)](#) for more information.

Last Will Settings

Topic:

QoS:

Message:

7. Under **Last Will Settings** do the following:

- a. Enter the *Last Will and Testament (LWT)* topic in this **Topic** field. This topic is sent to other clients when a client does not disconnect gracefully. An example topic might be `/client1/status`.
- b. Click the **QoS** field to select the desired Quality of Service setting.

QoS Setting	Description
0	At most once - Guarantees a best-effort delivery. It functions similar to the UDP protocol, where there is no guarantee of delivery from the client to the broker. The recipient does not acknowledge receipt of the message and the message is not stored and re-transmitted by the sender.
1	At least once - Guarantees that a message is delivered at least once to the receiver. The sender stores the message until it receives a <code>PUBACK</code> packet from the receiver that acknowledges receipt of the message.
2	Exactly once - The highest level of service and guarantees that each message is received only once by the intended recipients. The guarantee is provided by at least two request/responses between the sender and the receiver.

- c. Enter the message in the **Message** field.

Publish Topics			
Enable	Sensor	Topic	QoS
<input type="checkbox"/>	Motion	<input type="text"/>	<input type="text" value="0"/>
<input type="checkbox"/>	Light	<input type="text"/>	<input type="text" value="0"/>
<input type="checkbox"/>	Temp	<input type="text"/>	<input type="text" value="0"/>

Save

8. The final section is the **Publish Topics** section:
 - a. Click the **Enable** checkboxes in each row to enable topic publication. The **Sensor** column identifies the sensor role for each topic. These identifiers cannot be changed.
 - b. Enter the desired topic in the Topic fields. An example for **Motion** might be `building/conf1/door`.
 - c. Click the **QoS** field to select the desired Quality of Service setting.

QoS Setting	Description
0	At most once - Guarantees a best-effort delivery. It functions similar to the UDP protocol, where there is no guarantee of delivery from the client to the broker. The recipient does not acknowledge receipt of the message and the message is not stored and re-transmitted by the sender.
1	At least once - Guarantees that a message is delivered at least once to the receiver. The sender stores the message until it receives a <code>PUBACK</code> packet from the receiver that acknowledges receipt of the message.
2	Exactly once - The highest level of service and guarantees that each message is received only once by the intended recipients. The guarantee is provided by at least two request/responses between the sender and the receiver.

9. Click the **Save** button to commit changes.

Configuration and Management Interfaces

Web Server

The AT-OCS-900N includes a built-in web server. The web server is used for configuration and modification of the AT-OCS-900N operation. Refer to [Logging in to the Web Server \(page 12\)](#) for more information on accessing the web server.

First Time Registration page

This page is displayed when the AT-OCS-900N web server is launched for the first time.

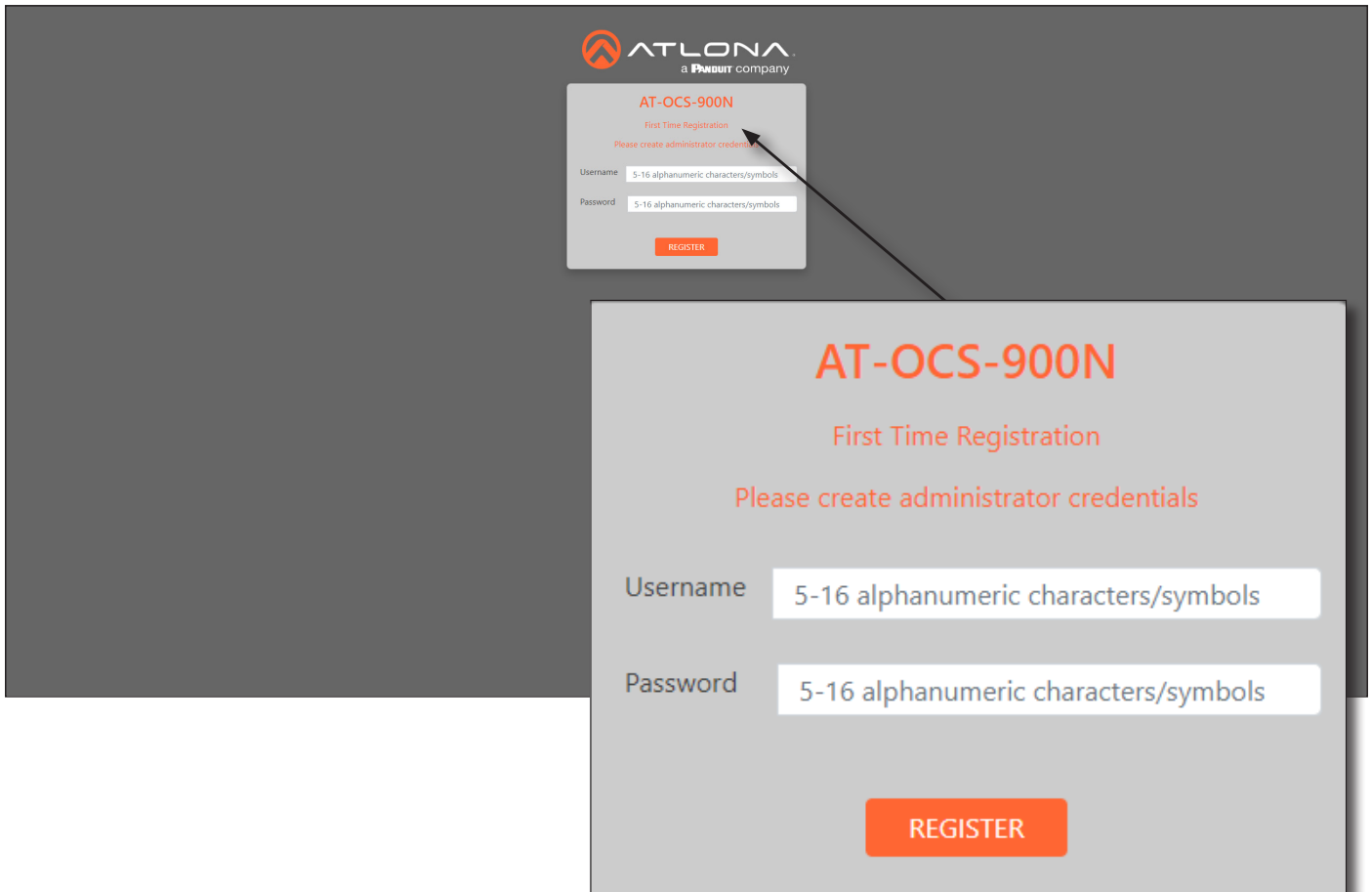

Username

Enter the desired username in this field. The username must be 5 - 16 characters in length, and can be any combination of letters, numbers, and symbols. Spaces are not permitted.

Password

Enter the desired password in this field. The password must be 5 - 16 characters in length, and can be any combination of letters, numbers, and symbols. Spaces are not permitted.

Register

Click this button to register the username and password with the AT-OCS-900N.

Configuration and Management Interfaces

Login page

This page is displayed when the IP address of the AT-OCS-900N is entered in the address bar of a web browser.

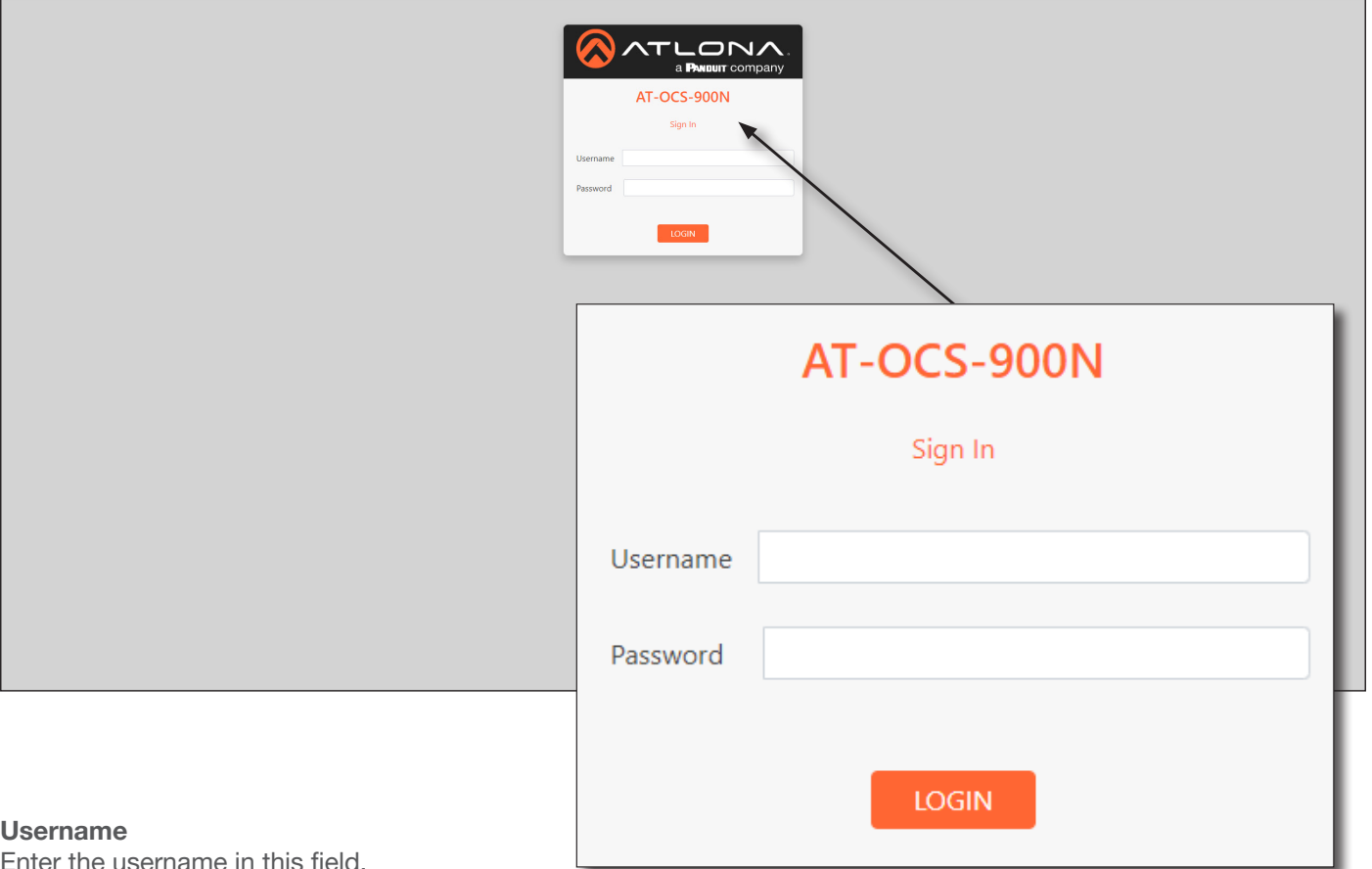

The image shows a screenshot of the AT-OCS-900N login page. The page features the ATLONA logo at the top left, followed by the text "AT-OCS-900N" and "Sign In". Below this, there are input fields for "Username" and "Password", and a "LOGIN" button. A callout box is overlaid on the right side of the page, providing a larger view of the login form. The callout box contains the text "AT-OCS-900N" and "Sign In" in red, followed by the "Username" and "Password" labels and their respective input fields, and the "LOGIN" button.

Username

Enter the username in this field.

Password

Enter the password in this field.

Login

Click this button to login.

Configuration and Management Interfaces

Dashboard page

After logging in, the **Dashboard** page will be displayed. This page provides basic information about the unit, including the model name, software version, and IP address information.

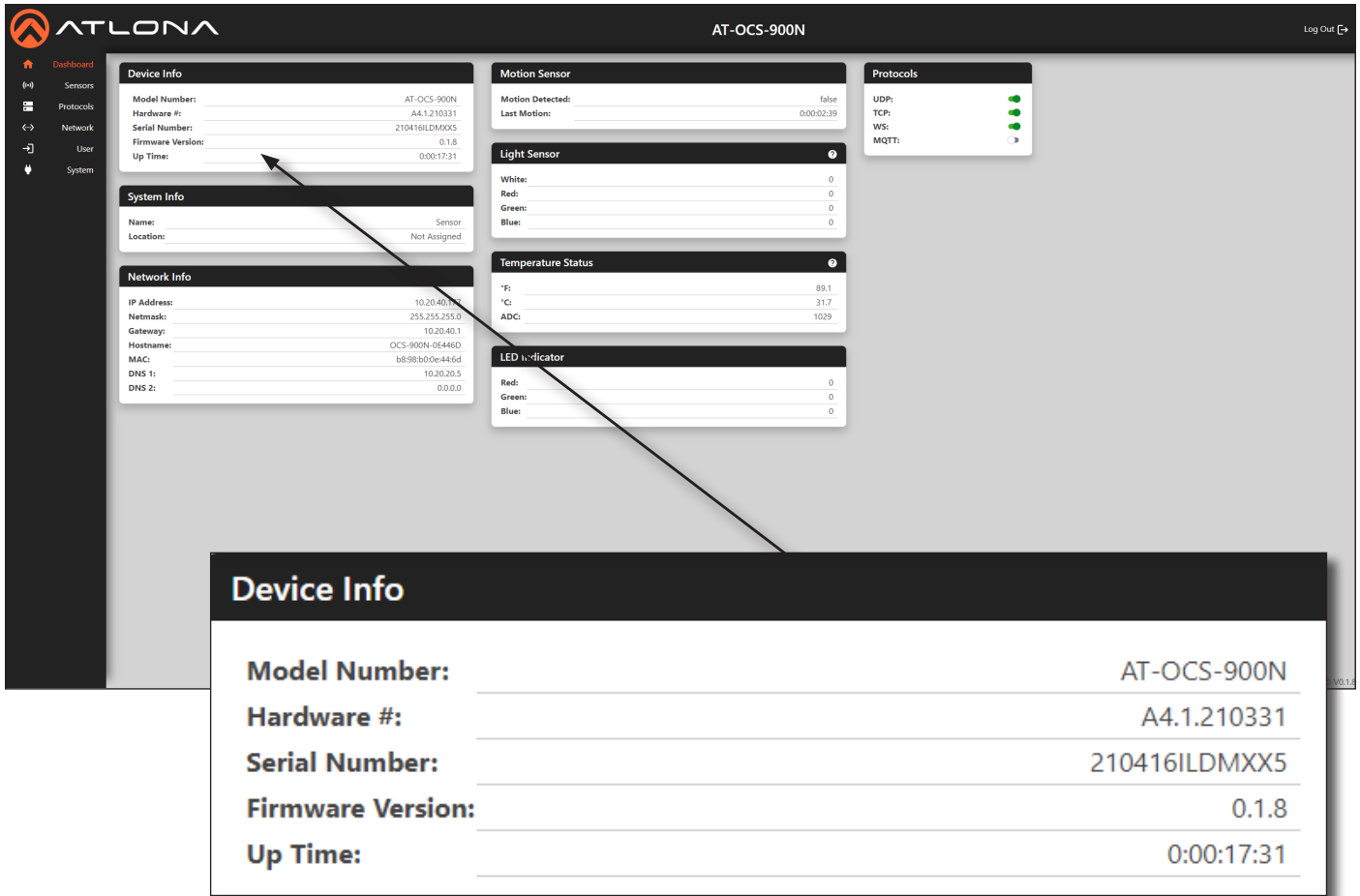

The screenshot shows the ATLONA AT-OCS-900N dashboard. A callout box highlights the **Device Info** section, which contains the following data:

Device Info	
Model Number:	AT-OCS-900N
Hardware #:	A4.1.210331
Serial Number:	210416ILDMMXX5
Firmware Version:	0.1.8
Up Time:	0:00:17:31

Device Info

Model Name

The model SKU of this product.

Hardware

The hardware version.

Serial Number

The serial number of the unit.

Firmware Version

The version of firmware that the AT-OCS-900N is running. Always make sure to check the AT-OCS-900N product page on the Atlona web site for the latest version of firmware.

Up Time

The time elapsed since the unit was powered on. Format is days, hours, minutes, and seconds.

Configuration and Management Interfaces

System Info	
Name:	Sensor
Location:	Not Assigned

System Info

Both of these fields can be modified under the **System** menu. Refer to [Setting Device Information \(page 19\)](#) for more information.

Name

The name of the AT-OCS-900N.

Location

The location of the AT-OCS-900N.

Network Info	
IP Address:	10.20.40.177
Netmask:	255.255.255.0
Gateway:	10.20.40.1
Hostname:	OCS-900N-0E446D
MAC:	b8:98:b0:0e:44:6d
DNS 1:	10.20.20.5
DNS 2:	0.0.0.0

Network Info

All of the following fields can be modified under the **Network** menu.

IP Address

The IP address of the AT-OCS-900N.

Netmask

The subnet mask of the unit.

Gateway

The default gateway (router) for the network.

Hostname

The hostname of the unit. Refer to [Changing the Hostname \(page 17\)](#) for more information.

MAC

The Media Access Control (MAC) address of the AT-OCS-900N.

DNS 1 / DNS 2

The address of the DNS servers.

Configuration and Management Interfaces

Motion Sensor	
Motion Detected:	false
Last Motion:	0:00:02:39

Motion Sensor

Motion Detected

Indicates if the AT-OCS-900N has detected movement within the area. Possible values: **true**, **false**.

Last Motion

Displays the time of the last-detected motion since the unit was powered on. If there is constant motion being detected, this clock will continue to run until movement is no longer detected. Time format is in days, hours, minutes, and seconds.

Light Sensor ?	
White:	0
Red:	0
Green:	0
Blue:	0

Light Sensor

White, Red, Green, Blue

These values display the values of the individual color components of the ambient light.

Temperature Status ?	
°F:	89.1
°C:	31.7
ADC:	1029

Temperature Status

°F, °C, ADC

Displays the temperature in the associated units.

Configuration and Management Interfaces

LED Indicator	
Red:	0
Green:	0
Blue:	0

LED Indicator

Red, Green, Blue

Displays the current color of the LED indicators. These values can be changed. Refer to [Setting the LED Color \(page 24\)](#) for more information.

Protocols	
UDP:	<input checked="" type="checkbox"/>
TCP:	<input checked="" type="checkbox"/>
WS:	<input checked="" type="checkbox"/>
MQTT:	<input type="checkbox"/>

Protocols

UDP, TCP, WS, MQTT

Each of these toggle switches provide quick enabling/disabling of these protocols. If a protocol is enabled, the toggle switch will be displayed in green. Refer to [Protocols Page \(page 41\)](#) for more information.

Configuration and Management Interfaces

Sensors Page

The **Sensors** page provides controls to adjust sensitivity and triggering.

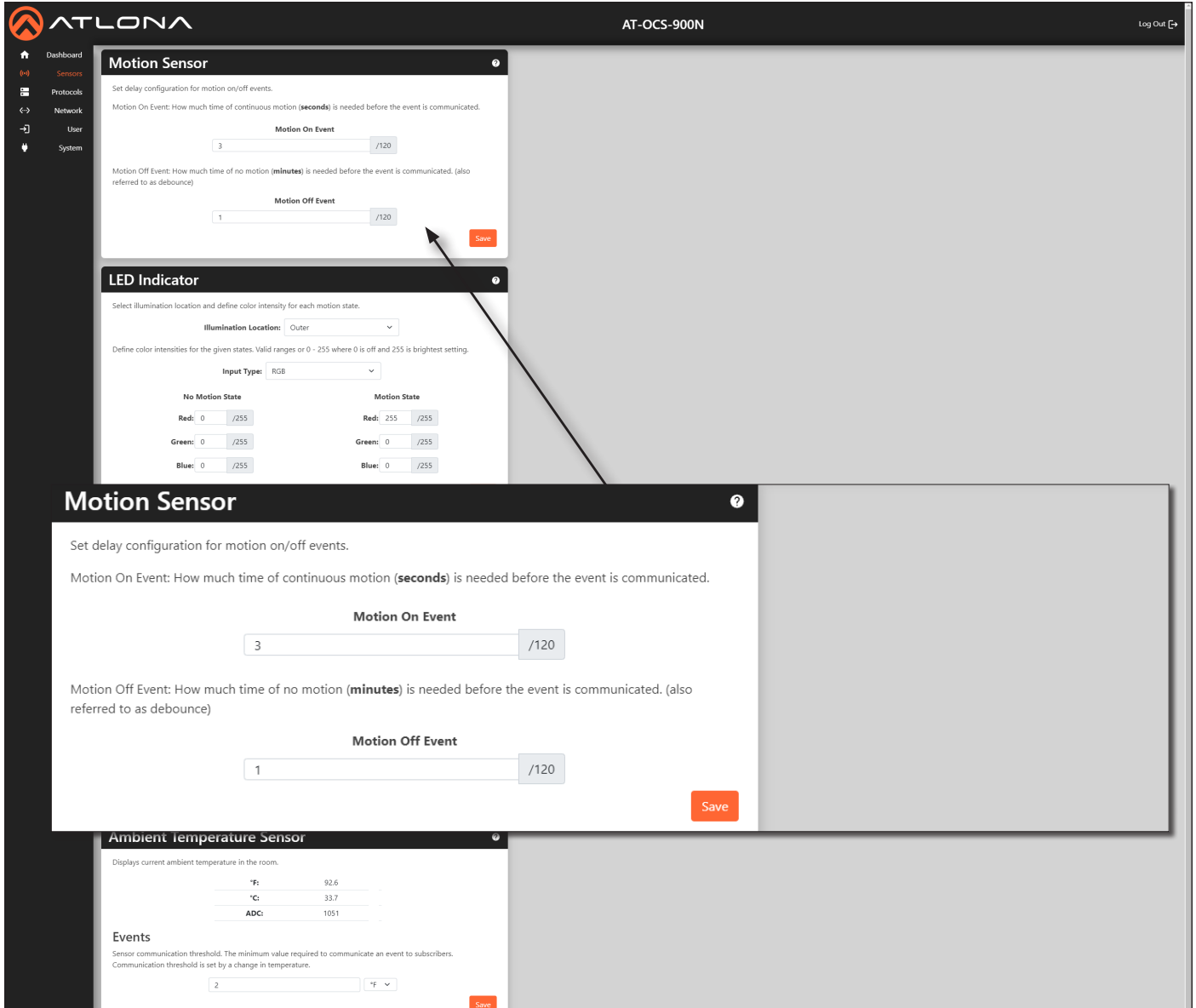

The screenshot displays the ATLONA web interface for the AT-OCS-900N device. The left sidebar shows navigation options: Dashboard, Sensors, Protocols, Network, User, and System. The main content area is divided into three sections:

- Motion Sensor:** This section allows for setting delay configurations for motion on/off events. It includes:
 - Motion On Event:** A text input field containing '3' and a range indicator '/120'. Description: "Motion On Event: How much time of continuous motion (seconds) is needed before the event is communicated."
 - Motion Off Event:** A text input field containing '1' and a range indicator '/120'. Description: "Motion Off Event: How much time of no motion (minutes) is needed before the event is communicated. (also referred to as debounce)".
 - A red **Save** button is located to the right of the Motion Off Event field.
- LED Indicator:** This section allows for selecting illumination location and defining color intensity for each motion state.
 - Illumination Location:** A dropdown menu set to 'Outer'.
 - Input Type:** A dropdown menu set to 'RGB'.
 - No Motion State:** RGB sliders for Red (0 /255), Green (0 /255), and Blue (0 /255).
 - Motion State:** RGB sliders for Red (255 /255), Green (0 /255), and Blue (0 /255).
- Ambient Temperature Sensor:** This section displays current ambient temperature in the room.

*F:	92.6
*C:	33.7
ADC:	1051

 Below the table is an **Events** section with a text input field containing '2' and a dropdown menu set to '*F'. A red **Save** button is located at the bottom right of this section.

Motion Sensor

Motion On Event

Sets the time period (in seconds) where continuous motion must be detected, before the event is triggered. Valid ranges are integers from 0 to 120.

Motion Off Event

Sets the time period (in minutes) where *no motion* must be detected, before the event is triggered. The Motion Off Event is also referred to as *debounce*. Valid ranges are integers from 0 to 120.

Save

Click this button to commit changes.

Configuration and Management Interfaces

LED Indicator ?

Select illumination location and define color intensity for each motion state.

Illumination Location:

Define color intensities for the given states. Valid ranges are 0 - 255 where 0 is off and 255 is brightest setting.

Input Type:

No Motion State	Motion State
Red: <input type="text" value="0"/> /255	Red: <input type="text" value="255"/> /255
Green: <input type="text" value="0"/> /255	Green: <input type="text" value="0"/> /255
Blue: <input type="text" value="0"/> /255	Blue: <input type="text" value="0"/> /255

Save

LED Indicator

This section allows modification of the illumination location and color intensity for each motion state.

Illumination Location

Assigns which set of LED indicators will be used when the lens is illuminated. Refer to [Setting the LED Color \(page 24\)](#) for more information.

Modes	Description
Outer	Uses the outer three LED indicators for illumination.
Center	Uses a single LED, in the center of the unit, for illumination.

Input Type

Click this drop-down list to specify either RGB or Hex values for the motion state color.

Modes	Description
RGB	Uses RGB values to specify the motion state color. Valid ranges for each RGB color component are 0 to 255.
Hex	Used hexadecimal values to specify the motion state color. Valid range is #000000 to #FFFFFF.

Save

Click this button to commit changes.

Configuration and Management Interfaces

Ambient Light Sensor ?

Select ambient light sensitivity settings. For brighter environments, set sensitivity to a lower number. For darker environments, set sensitivity to a higher number.

Sensitivity:

If sensor is reporting values at or above 65,535. The sensor is experiencing a saturated level and sensitivity should be decreased.

White:	0
Red:	0
Green:	0
Blue:	0

Events

Sensor communication threshold. The minimum value required to communicate an event. Communication threshold is set by a change in white light intensity.

Save

Ambient Light Sensor

This section allows for the adjustment of ambient light sensitivity. For brighter environments, set the sensitivity to a lower value; darker environments should be set to a higher value.

Input Type

Click this drop-down list to specify the sensitivity setting. Valid ranges are 0 to 5.

Events

Sets the sensor communication threshold. This is the minimum value required to trigger an event. The communication threshold is set by modification of the white light intensity. Valid range is 0 to 300.

Save

Click this button to commit changes.

Ambient Temperature Sensor ?

Displays current ambient temperature in the room.

°F:	92.6
°C:	33.7
ADC:	1051

Events

Sensor communication threshold. The minimum value required to communicate an event to subscribers. Communication threshold is set by a change in temperature.

Save

Ambient Temperature Sensor

This section reports the current ambient temperature in the room in °F, °C, and ADC. An event can be triggered from this section, based on the variation in temperature.

Events

Enter the variation in temperature in the first field. When this value is reached, the event will be triggered. Click the drop-down list, on the right of this field, to set the units to °F, °C, or ADC.

Save

Click this button to commit changes.

Configuration and Management Interfaces

Protocols Page

The **Protocols** page provides setup and configuration for available protocols.

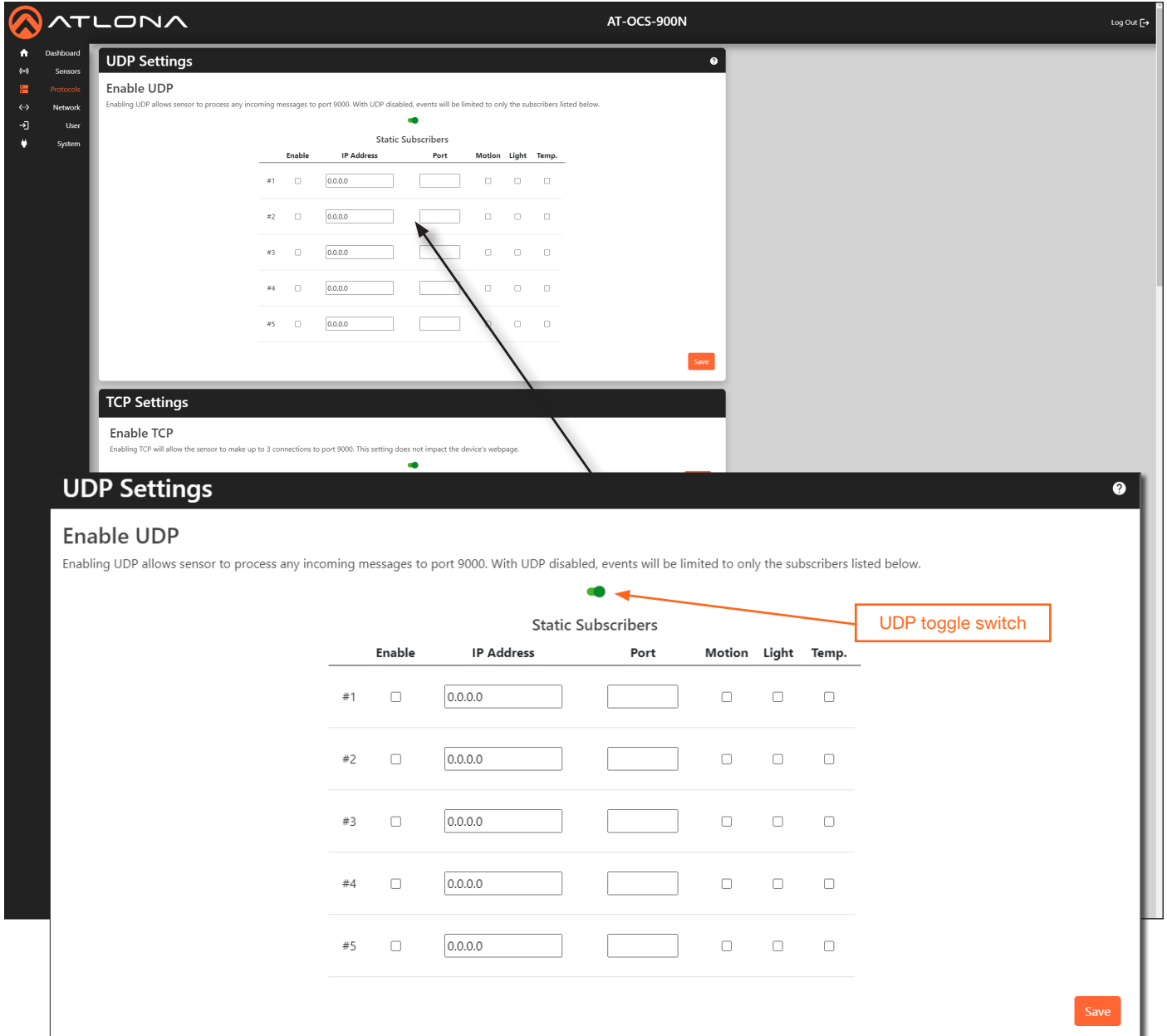

UDP Settings

Enable UDP

Enabling UDP allows sensor to process any incoming messages to port 9000. With UDP disabled, events will be limited to only the subscribers listed below.

Static Subscribers

	Enable	IP Address	Port	Motion	Light	Temp.
#1	<input type="checkbox"/>	0.0.0.0		<input type="checkbox"/>	<input type="checkbox"/>	<input type="checkbox"/>
#2	<input type="checkbox"/>	0.0.0.0		<input type="checkbox"/>	<input type="checkbox"/>	<input type="checkbox"/>
#3	<input type="checkbox"/>	0.0.0.0		<input type="checkbox"/>	<input type="checkbox"/>	<input type="checkbox"/>
#4	<input type="checkbox"/>	0.0.0.0		<input type="checkbox"/>	<input type="checkbox"/>	<input type="checkbox"/>
#5	<input type="checkbox"/>	0.0.0.0		<input type="checkbox"/>	<input type="checkbox"/>	<input type="checkbox"/>

UDP toggle switch

TCP Settings

Enable TCP

Enabling TCP will allow the sensor to make up to 3 connections to port 9000. This setting does not impact the device's webpage.

UDP Settings

Enable UDP

Enabling UDP allows sensor to process any incoming messages to port 9000. With UDP disabled, events will be limited to only the subscribers listed below.

Static Subscribers

	Enable	IP Address	Port	Motion	Light	Temp.
#1	<input type="checkbox"/>	0.0.0.0		<input type="checkbox"/>	<input type="checkbox"/>	<input type="checkbox"/>
#2	<input type="checkbox"/>	0.0.0.0		<input type="checkbox"/>	<input type="checkbox"/>	<input type="checkbox"/>
#3	<input type="checkbox"/>	0.0.0.0		<input type="checkbox"/>	<input type="checkbox"/>	<input type="checkbox"/>
#4	<input type="checkbox"/>	0.0.0.0		<input type="checkbox"/>	<input type="checkbox"/>	<input type="checkbox"/>
#5	<input type="checkbox"/>	0.0.0.0		<input type="checkbox"/>	<input type="checkbox"/>	<input type="checkbox"/>

Save

UDP Settings

This section allows the sensor to process any incoming messages to port 9000. If UDP is disabled, then events will be limited to only the subscribers below. To enable or disable UDP, click the toggle switch. If UDP is enabled, then the toggle switch will be green.

Enable

Click this checkbox to enable or disable subscription of the information in the row (**IP Address**, **Port**, **Motion**, **Light**, **Temp.**).

Configuration and Management Interfaces

UDP Settings ?

Enable UDP
 Enabling UDP allows sensor to process any incoming messages to port 9000. With UDP disabled, events will be limited to only the subscribers listed below.



Static Subscribers

	Enable	IP Address	Port	Motion	Light	Temp.
#1	<input type="checkbox"/>	<input type="text" value="0.0.0.0"/>	<input type="text"/>	<input type="checkbox"/>	<input type="checkbox"/>	<input type="checkbox"/>
#2	<input type="checkbox"/>	<input type="text" value="0.0.0.0"/>	<input type="text"/>	<input type="checkbox"/>	<input type="checkbox"/>	<input type="checkbox"/>
#3	<input type="checkbox"/>	<input type="text" value="0.0.0.0"/>	<input type="text"/>	<input type="checkbox"/>	<input type="checkbox"/>	<input type="checkbox"/>
#4	<input type="checkbox"/>	<input type="text" value="0.0.0.0"/>	<input type="text"/>	<input type="checkbox"/>	<input type="checkbox"/>	<input type="checkbox"/>
#5	<input type="checkbox"/>	<input type="text" value="0.0.0.0"/>	<input type="text"/>	<input type="checkbox"/>	<input type="checkbox"/>	<input type="checkbox"/>

Save

IP Address

Enter the IP address from where messages will be received.

Port

Enter the port from where messages will be received.

Motion, Light, Temp.

Click these checkboxes to enable or disable the feature. When a feature is enable, the checkbox will be checked.

Save

Click this button to commit changes.

TCP Settings

Enable TCP
 Enabling TCP will allow the sensor to make up to 3 connections to port 9000. This setting does not impact the device's webpage.



TCP toggle switch

Save

TCP Settings

Enabling TCP will allow the sensor to create 3 simultaneous connections to port 9000. This setting does not impact the web server for the AT-OCS-900N. To enable or disable TCP, click the toggle switch. If TCP is enabled, then the toggle switch will be green.

Save

Click this button to commit changes.

Configuration and Management Interfaces

WebSocket Settings

Enable Websockets

Enabling websockets will allow the sensor to make up to 3 connections to `wss://10.20.40.177/ws`. This setting does not impact the device's webpage.

Control URL

WS toggle switch

WebSocket Settings

To enable or disable WebSockets, click the toggle switch. If WebSockets are enabled, then the toggle switch will be green. When this feature is enabled, up to 3 simultaneous connections can be made to the AT-OCS-900N. The control URL that is displayed, will depend on whether TLS is enabled or not.

If TLS is *enabled*, then the control URL will be `wss://[ip-address-of-AT-OCS-900N]/ws`.

If TLS is *disabled*, then the control URL will be `ws://[ip-address-of-AT-OCS-900N]/ws`.

Refer to [Using Transport Layer Security \(TLS\) \(page 16\)](#) for more information. Note that enabling or disabling this feature does not impact the web server for the AT-OCS-900N.

Save

Click this button to commit changes.

MQTT Client

Enable MQTT

Enabling MQTT allows you subscribe to a broker and transmit events.

Connection Settings

Broker:	<input type="text" value="mqtt.eclipse.org"/>
Port:	<input type="text" value="1883"/>
Client-ID:	<input type="text" value="OCS-900N-0E446D"/>
Keep Alive:	<input type="text" value="60"/>
<input type="checkbox"/> Clean Session	

MQTT Client

Enabling MQTT will allow the client device(s) to subscribe to the MQ broker (server) and receive information on specified topics. Refer to [Using MQTT \(page 28\)](#) for more information.

Enable MQTT

Click this toggle switch to enable or disable MQTT. When enabled, this toggle switch will be green.

Broker

Enter the broker URL in this field.

Port

Enter the port ID in this field.

Client-ID

Enter the client ID in this field.

Configuration and Management Interfaces

MQTT Client

Enable MQTT

Enabling MQTT allows you subscribe to a broker and transmit events.

Connection Settings

Broker:	<input type="text" value="mqtt.eclipse.org"/>
Port:	<input type="text" value="1883"/>
Client-ID:	<input type="text" value="OCS-900N-0E446D"/>
Keep Alive:	<input type="text" value="60"/>
<input type="checkbox"/> Clean Session	

Keep Alive

This value is used to make sure that the connection between the broker and the client are open and that both devices are aware of being connected. If this value is set to 0 (zero), then the keep alive mechanism is deactivated.

Clean Session

When a client connects to a broker, it can do so in one of two ways: non-persistent (clean) or persistent connection. Check this box to use a non-persistent (clean) connection.

Authentication Settings

Username:	<input type="text"/>
Password:	<input type="password"/>
<input type="checkbox"/> Authentication	

Username

Enter the user name for the broker in this field.

Password

Enter the required password in this field.

Authentication

Click this checkbox to toggle between enabling and disabling authentication. If the checkbox is checked, then this feature is enabled.

Last Will Settings

Topic:	<input type="text"/>
QoS:	<input type="text" value="0"/>
Message:	<input type="text"/>

The **Last Will Settings**, more commonly referred to as *Last Will and Testament (LWT)*, is provided to notify other clients about a client that experiences an abrupt disconnection. When a client connects to a broker, it can communicate its last will message to the broker. The broker will retain this message until a client has disconnected “ungracefully”.

Configuration and Management Interfaces

Last Will Settings

Topic:

QoS:

Message:

Topic

Enter the topic in this field.

QoS

Click this field to select the Quality of Service (QoS) value.

QoS Setting	Description
0	At most once - Guarantees a best-effort delivery. It functions similar to the UDP protocol, where there is no guarantee of delivery from the client to the broker. The recipient does not acknowledge receipt of the message and the message is not stored and re-transmitted by the sender.
1	At least once - Guarantees that a message is delivered at least once to the receiver. The sender stores the message until it receives a <code>PUBACK</code> packet from the receiver that acknowledges receipt of the message.
2	Exactly once - The highest level of service and guarantees that each message is received only once by the intended recipients. The guarantee is provided by at least two request/responses between the sender and the receiver.

Message

Enter the message in this field.

Publish Topics

Enable	Sensor	Topic	QoS
<input type="checkbox"/>	Motion	<input type="text"/>	<input type="text" value="0"/>
<input type="checkbox"/>	Light	<input type="text"/>	<input type="text" value="0"/>
<input type="checkbox"/>	Temp	<input type="text"/>	<input type="text" value="0"/>

The **Publish Topics** section provides enabling and disabling of which topics are published. Quality of Service (QoS) for each topic can also be specified.

Enable

Click this checkboxes to enable or disable the desired topic for each sensor attribute. If the checkbox is checked, then this feature is enabled.

Sensor

Displays the attribute associated with the topic.

Topic

Enter the topic in this field.

QoS

Click these fields to select the Quality of Service. Valid ranges are 0 - 2. Refer to the QoS Setting table, above, for a description of QoS values.

Configuration and Management Interfaces

Network Page

The **Network** page provides controls to adjust network settings.

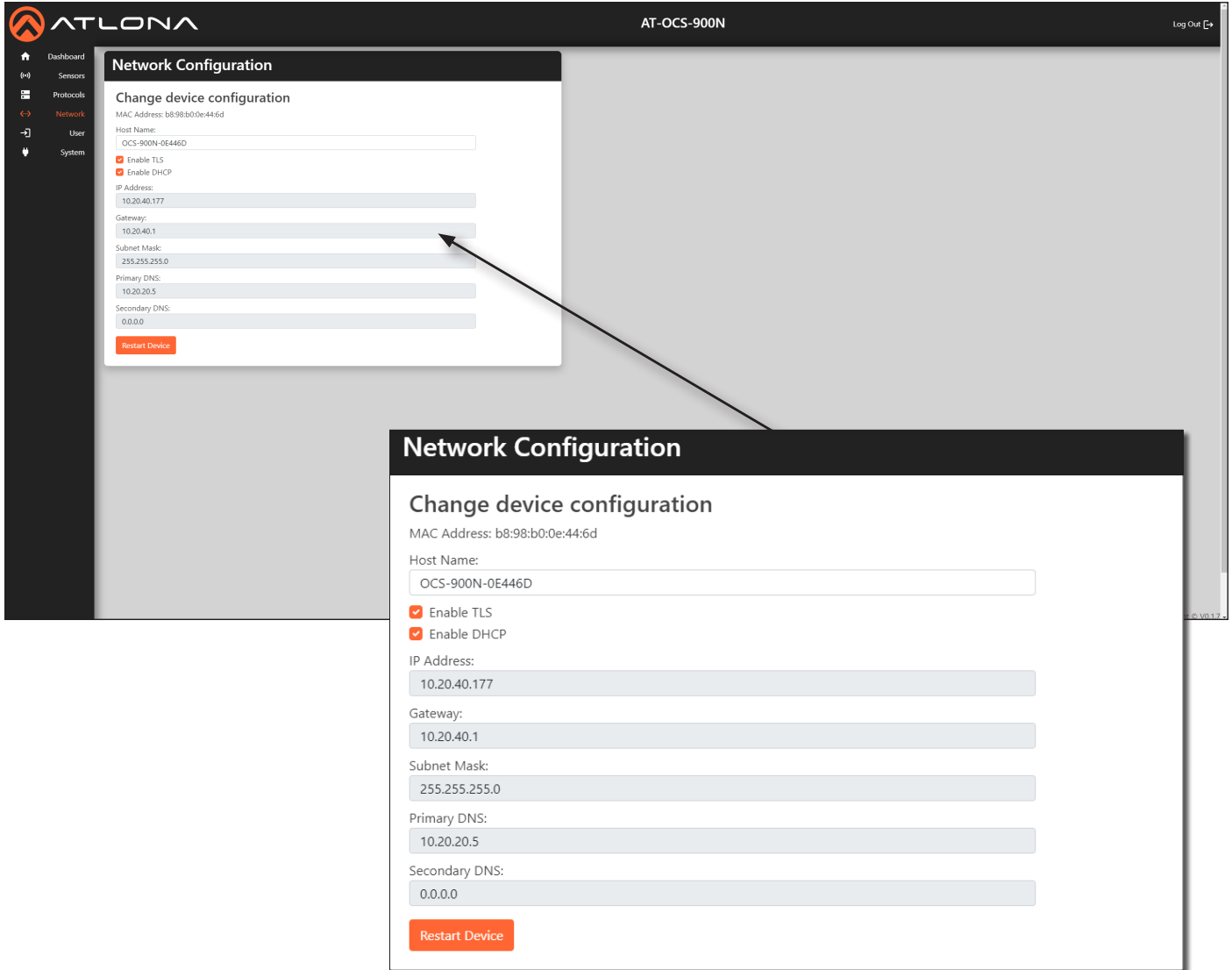

Network Configuration

Host Name

Enter the desired host name in this field. Refer to [Changing the Hostname \(page 17\)](#) for more information.

Enable TLS

Click this checkbox to enable or disable Transport Layer Security (TLS). This feature is enabled by default. When enabled, the checkbox will be checked.

Enable DHCP

Click this checkbox to enable or disable DHCP. This feature is enabled by default. When enabled, the checkbox will be checked.

Configuration and Management Interfaces

Network Configuration

Change device configuration

MAC Address: b8:98:b0:0e:44:6d

Host Name:

OCS-900N-0E446D

Enable TLS

Enable DHCP

IP Address:

10.20.40.177

Gateway:

10.20.40.1

Subnet Mask:

255.255.255.0

Primary DNS:

10.20.20.5

Secondary DNS:

0.0.0.0

Restart Device

IP Address

Enter the desired IP address for the AT-OCS-900N in this field. This field can only be changed when **Enable DHCP** is disabled.

Gateway

Enter the IP address of the default gateway (router) in this field. This field can only be changed when **Enable DHCP** is disabled.

Subnet Mask

Enter the subnet mask in this field. This field can only be changed when **Enable DHCP** is disabled.

Primary DNS / Secondary DNS

Enter the IP address of the primary and secondary DNS servers in these fields. he DNS Server #1 and DNS Server #2 fields. If DNS is not required, these fields can be set to 0 . 0 . 0 . 0 . These fields can only be changed when **Enable DHCP** is disabled.

Restart Device

Click this button to commit changes and restart the unit.

Configuration and Management Interfaces

User Page

The **User** page allows the username and password to be changed. Refer to [Resetting Login Credentials \(page 18\)](#) for more information.

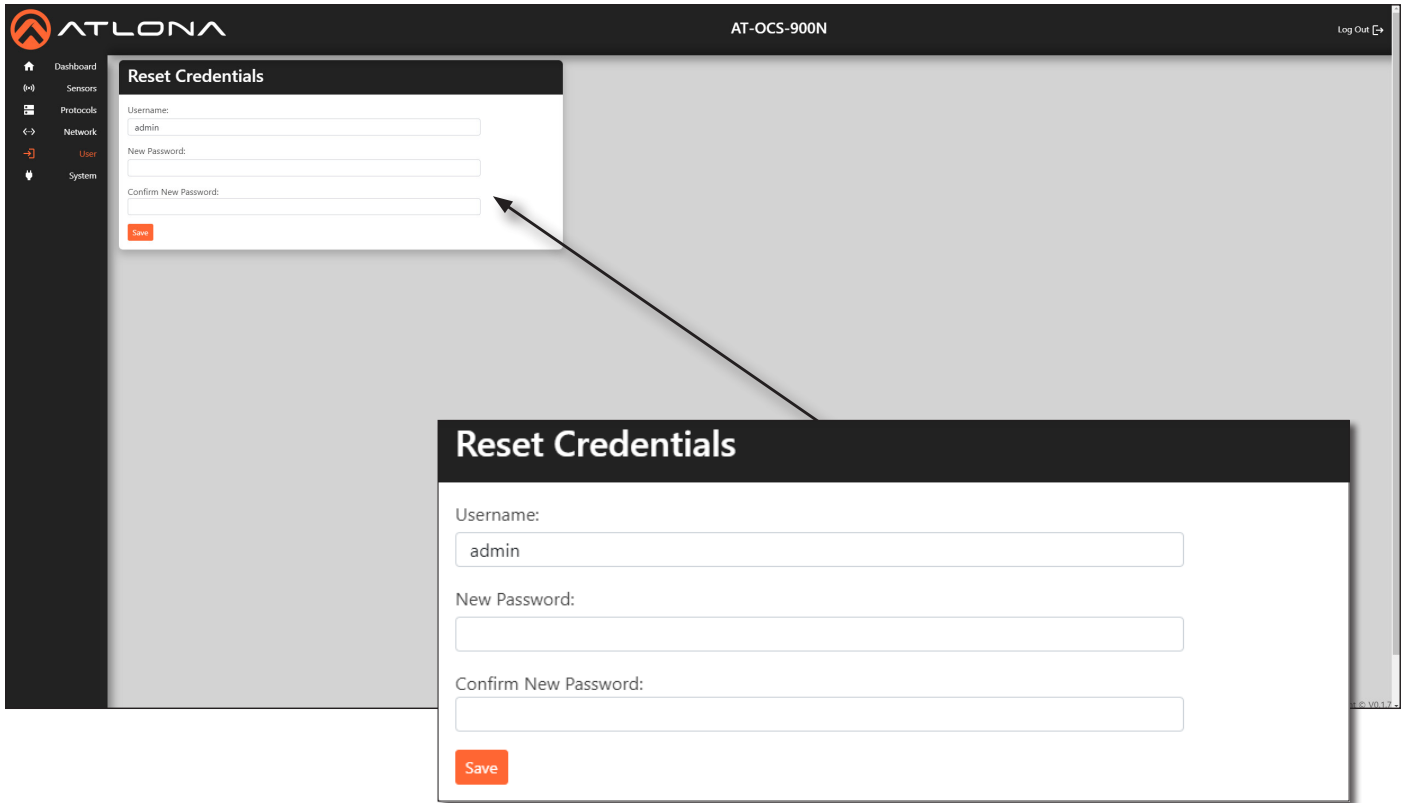

Reset Credentials

Username

Enter the desired user name in this field.

New Password

Enter the desired password in this field.

Confirm New Password

Confirm the password by entering it in this field.

Save

Click this button to commit changes.

Configuration and Management Interfaces

System Page

The **System** page provides management of various system settings.

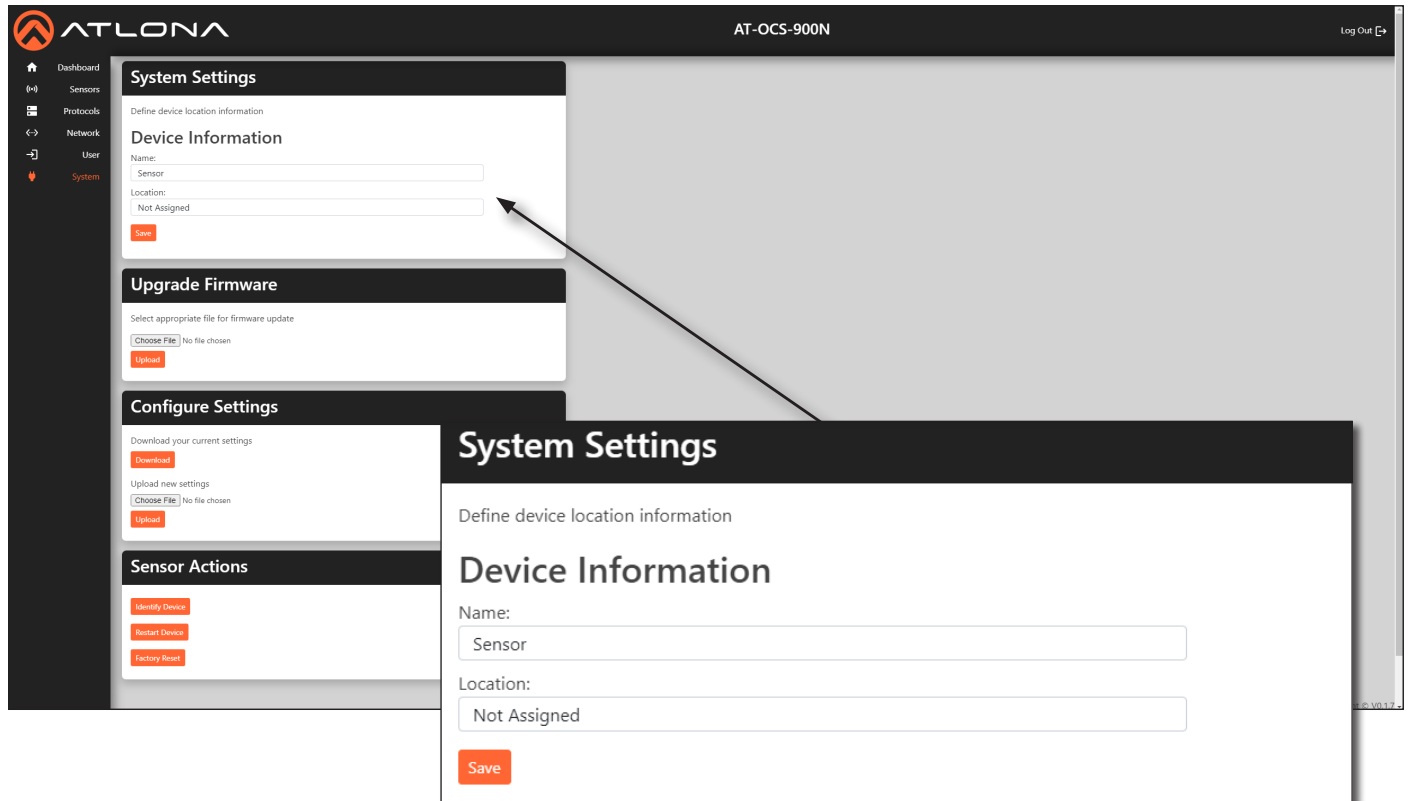

System Settings

Name

Enter the name of the device in this field. Refer to [Setting Device Information \(page 19\)](#) for more information.

Location

Enter the location of the AT-OCS-900N in this field.

Save

Click this button to commit changes.

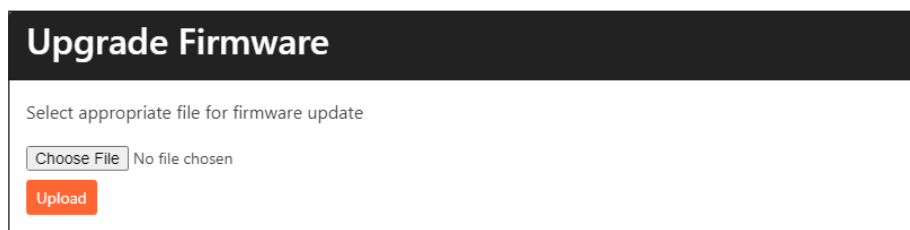

Upgrade Firmware

Choose File

Click this button to select the firmware file. Refer to [Updating the Firmware \(page 51\)](#) for more information.

Upload

Click this upload the firmware to the AT-OCS-900N and begin the firmware upgrade process.

Configuration and Management Interfaces

Configure Settings

Download your current settings

Download

Upload new settings

Choose File No file chosen

Upload

Configure Settings

Download

Click this button to download the current settings to a .json file.

Choose File

Click this button to select the .json settings file.

Upload

Click this button to upload the desired .json settings file to the AT-OCS-900N.

Sensor Actions

Identify Device

Restart Device

Factory Reset

Sensor Actions

Identify Device

Click this button to identify the AT-OCS-900N within the room. During the identification procedure, the LED indicators within the unit will flash for 30 seconds.

Restart Device

Click this button to restart the unit. Settings are preserved during a restart.

Factory Reset

Click this button to restore the unit to factory-default settings.

Appendix

Updating the Firmware

Using the Web Server

Requirements:

- AT-OCS-900N
 - Firmware file
 - Computer on the same network as the AT-OCS-900N
1. Download the firmware file from atlona.com and extract the contents of the .zip file to a folder on the computer desktop.
 2. Login to the web server. Refer to [Logging in to the Web Server \(page 12\)](#).
 3. Click **System** in the menu bar.
 4. Locate the **Upgrade Firmware** window group and click the **Choose File** button.

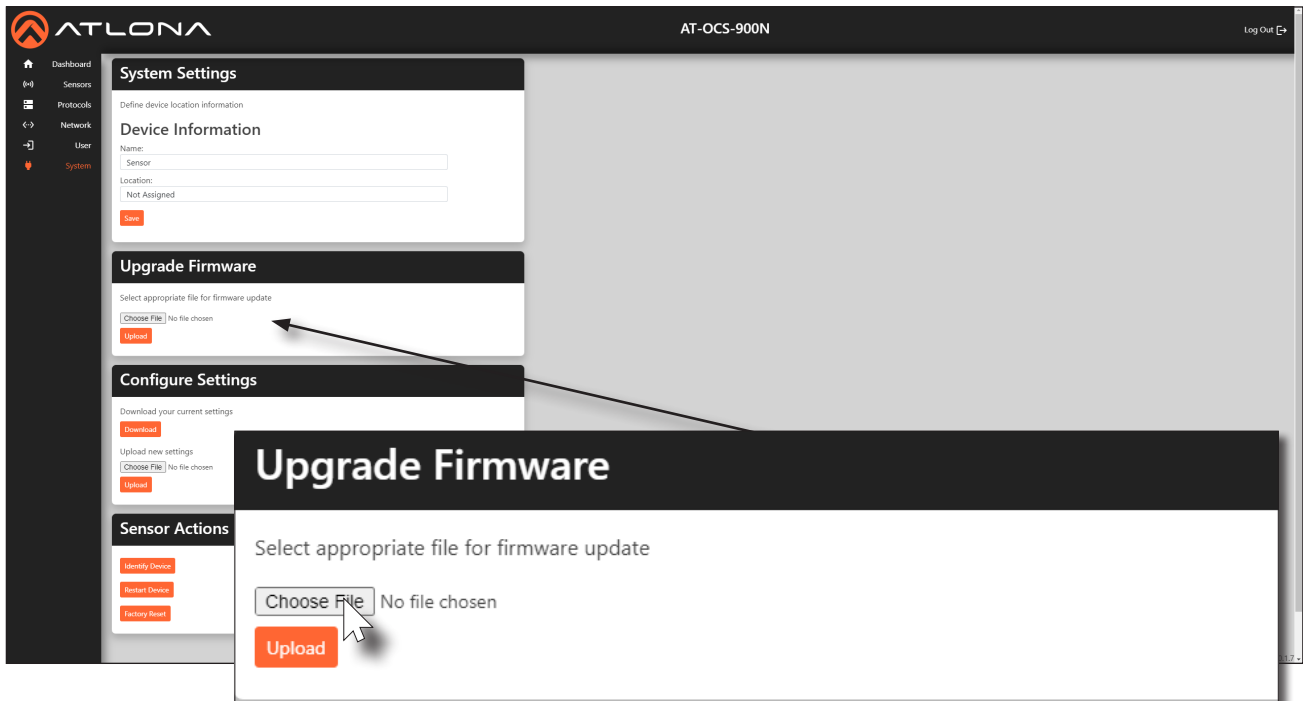

5. The **Open** dialog will be displayed. Select the firmware (.bin) file and click the **Open** button.
6. Click the name of the firmware file will be displayed next to the **Choose File** button.

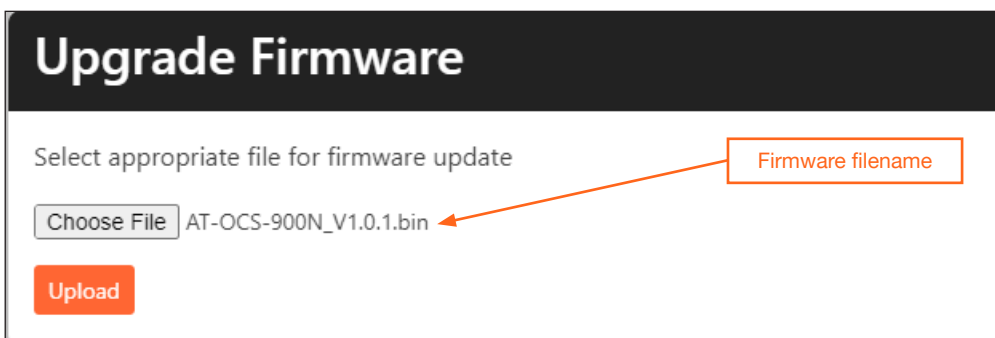

7. Click the **Upload** button.
8. Another screen will be displayed, showing the progress of the update procedure.

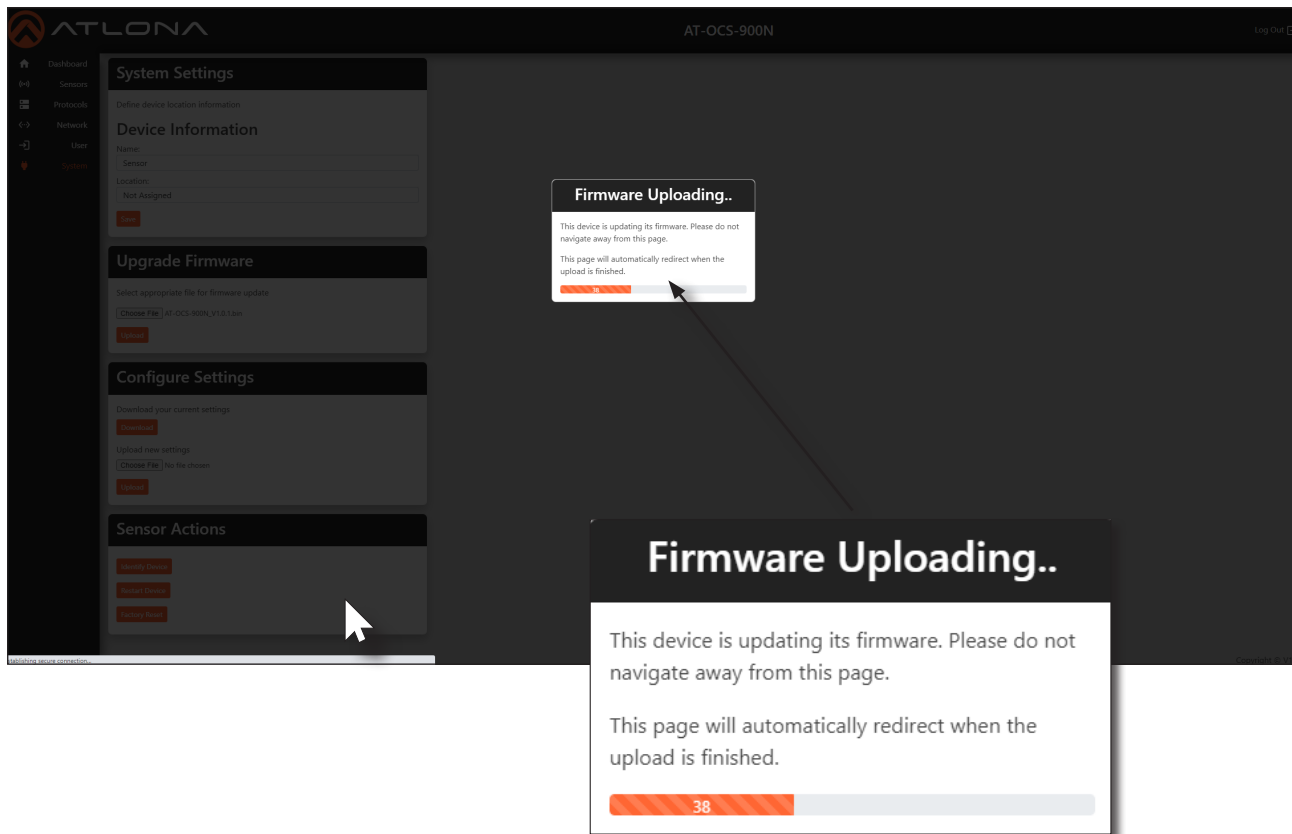

IMPORTANT: Make sure to leave this page open during the upload procedure. Do not close this window while the firmware is being updated.

9. Once the upload process is complete, the AT-OCS-900N will automatically reboot.

Booting up...

Upload was successful, This page will redirect after the device has restarted.

10. When the **Login** page is displayed, the firmware update process is complete.

Integration with Velocity



IMPORTANT: Velocity version 2.4.5 or higher required for integration.

Driver Configuration

1. Open the desired web browser and enter the IP address of Velocity.
2. Access the **Configure Equipment** window for the AT-OCS-900N. Refer to the Velocity User Manual if necessary.
3. The following screen will be displayed.

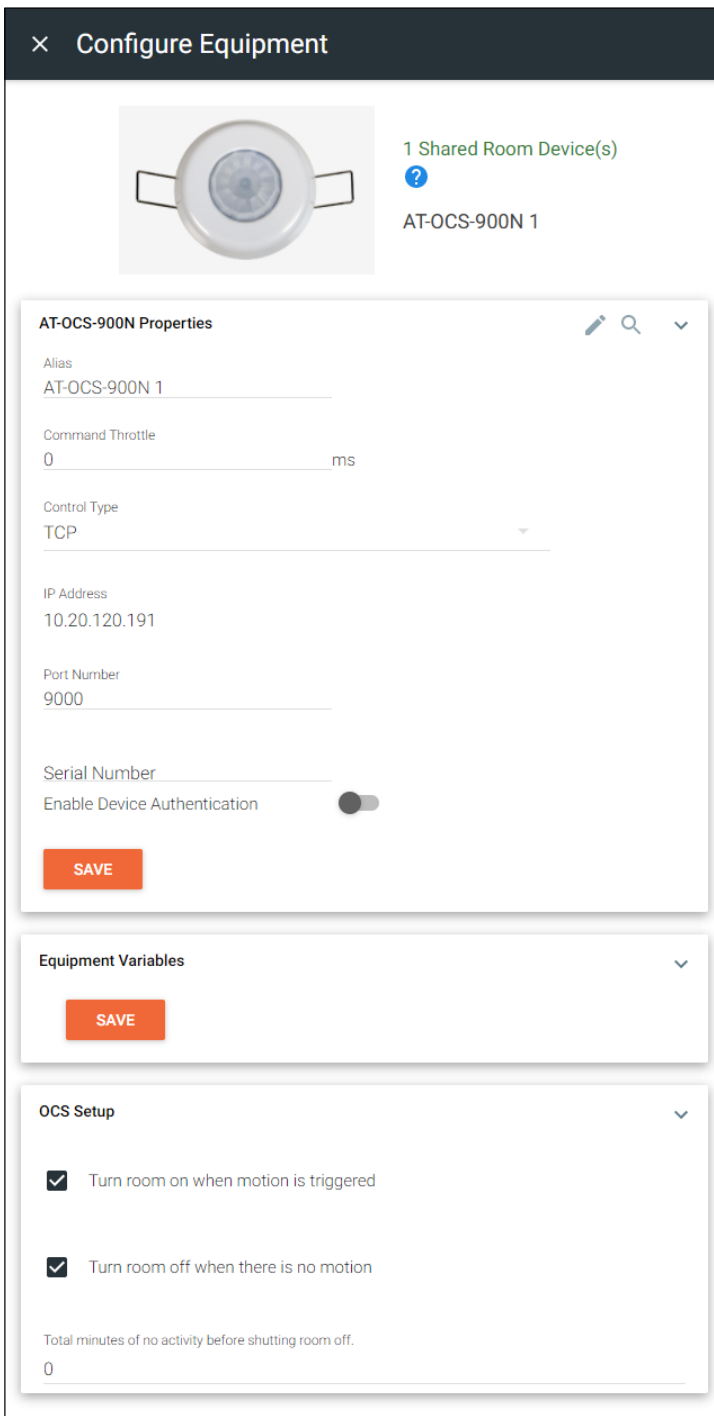

The screenshot shows the 'Configure Equipment' window for an AT-OCS-900N device. At the top, there is a close button (X) and the title 'Configure Equipment'. Below the title, there is a device image and a label '1 Shared Room Device(s)' with a question mark icon, and 'AT-OCS-900N 1'. The main configuration area is titled 'AT-OCS-900N Properties' and includes the following fields:

- Alias: AT-OCS-900N 1
- Command Throttle: 0 ms
- Control Type: TCP
- IP Address: 10.20.120.191
- Port Number: 9000
- Serial Number: (empty field)
- Enable Device Authentication: (toggle switch, currently off)

Below the properties section, there are two expandable sections:

- Equipment Variables**: Contains a 'SAVE' button.
- OCS Setup**: Contains two checked checkboxes:
 - Turn room on when motion is triggered
 - Turn room off when there is no motionBelow these checkboxes is a field for 'Total minutes of no activity before shutting room off.' with the value '0'.

- Under the **AT-OCS-900N Properties** window group, modify any settings as desired, then click the **SAVE** button.

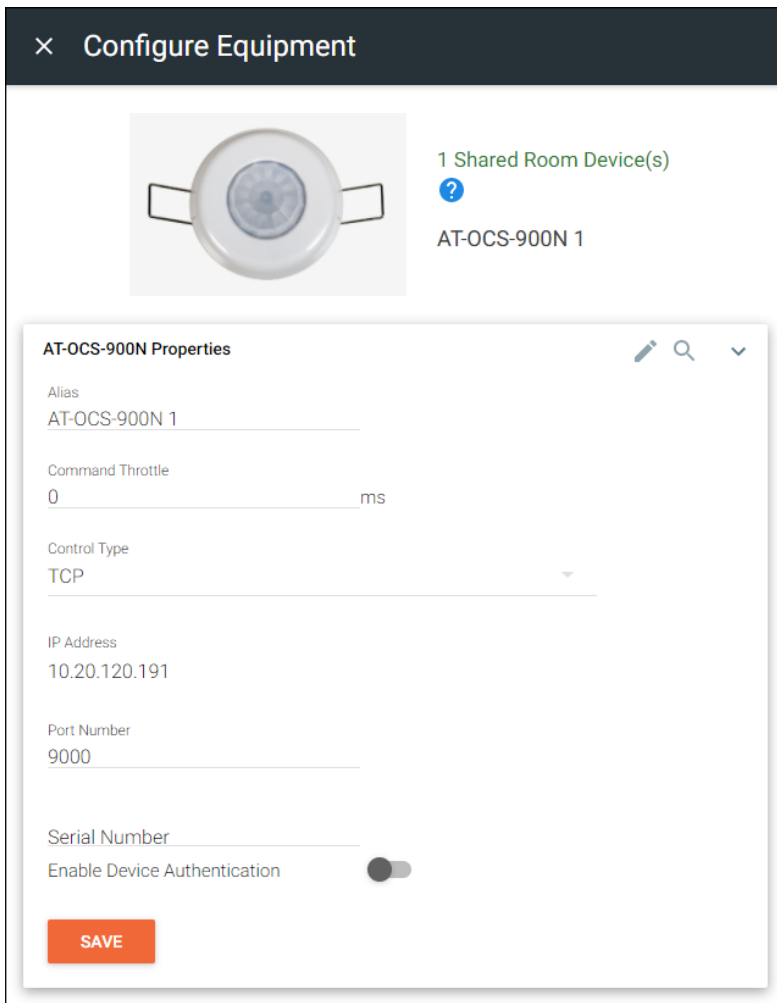

Configure Equipment

 1 Shared Room Device(s)
 AT-OCS-900N 1

AT-OCS-900N Properties

Alias
 AT-OCS-900N 1

Command Throttle
 0 ms

Control Type
 TCP

IP Address
 10.20.120.191

Port Number
 9000

Serial Number
 Enable Device Authentication

SAVE

- Locate the **OCS Setup** window group.
- Click the desired checkboxes to customize the settings:
 - If the **Turn room on when motion is triggered** box is checked, then the room will be turned on when occupied. When this feature is enabled, a checkmark will appear in the box.
 - If the **Turn room off when there is no motion** box is checked, then the room will be turned off when vacant. When this feature is enabled, a checkmark will appear in the box.
- In the **Total minutes of no activity before shutting room off** field, enter the time interval (in minutes). This is inclusive of the motion off event timer within the AT-OCS-900N



OCS Setup

Turn room on when motion is triggered

Turn room off when there is no motion

Total minutes of no activity before shutting room off.
 0

Device Variables

Device variables are used when creating macros which allow for scripted automation of events. Refer to the Velocity User Manual for more information on creating and using macros.

1. Under the **Variables** page, click the **DEVICE VARIABLES** tab.
2. The following screen will be displayed.

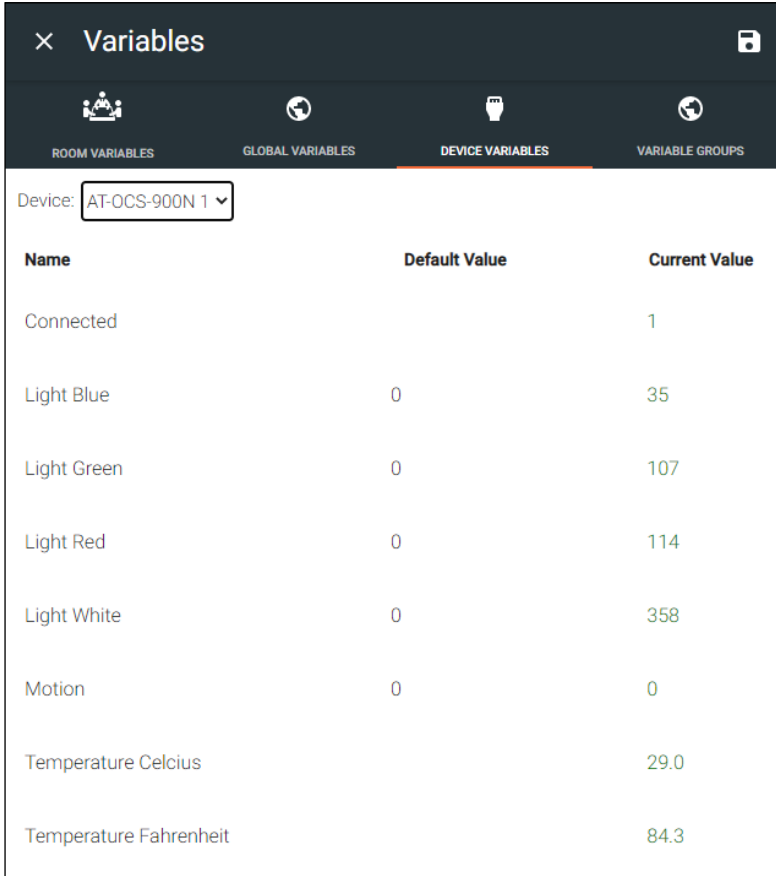

The screenshot shows a 'Variables' window with a dark header. Below the header are four tabs: ROOM VARIABLES, GLOBAL VARIABLES, DEVICE VARIABLES (which is selected and highlighted in red), and VARIABLE GROUPS. A dropdown menu shows 'Device: AT-OCS-900N 1'. Below this is a table with three columns: Name, Default Value, and Current Value.

Name	Default Value	Current Value
Connected		1
Light Blue	0	35
Light Green	0	107
Light Red	0	114
Light White	0	358
Motion	0	0
Temperature Celcius		29.0
Temperature Fahrenheit		84.3

The AT-OCS-900N sensors will report their current values and display them in this window, as shown in the illustration above. The variable names (under the **Name** column) can be used to display, for example, the current temperature on a touch panel, or to conditionally trigger an event. Note that these variables values cannot be modified through Velocity.

Integration with AT-OME-MS52W / AT-UHD-SW-510W

The following provides instructions on adding the AT-OCS-900N occupancy sensor as a device. The **AutoSwitch** feature on the AT-OME-MS52W / AT-UHD-SW-510W does not need to be enabled for this to work.



IMPORTANT: A username and password must be configured on the AT-OCS-900N before using the device with the AT-OME-MS52W / AT-UHD-SW-510W.

1. Connect the AT-OCS-900N to the network. Refer to the AT-OCS-900N User Manual for more information.
2. Login to the web server of the AT-OME-MS52W / AT-UHD-SW-510W.
3. Click **Display** in the side menu bar. The AT-OME-MS52W interface is shown as an example.
4. Click the **Display Control Method** drop-down list and select **Occupancy Sensor**.

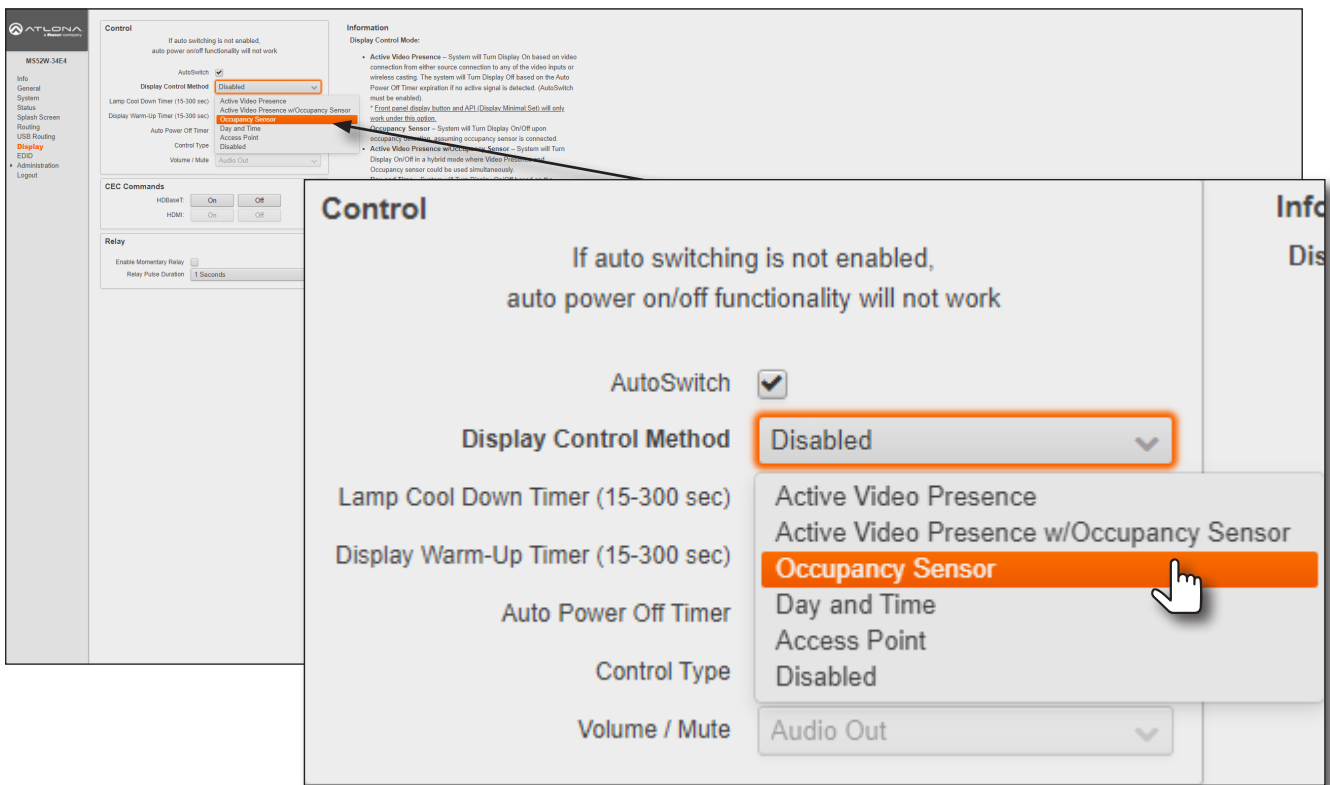

5. The **Occupancy Sensor Control** window group will be displayed, as shown:

Occupancy Sensor Control

Turn Display On on Occupancy

Turn Display Off on Vacancy

IP

Port

Sensors

Status	IP		

6. Click the **Turn Display On on Occupancy** checkbox to enable or disable this feature. When enabled, a checkmark will appear in the checkbox and the occupancy sensor will power-on the display when the room is occupied.
7. Click the **Turn Display Off on Vacancy** checkbox to enable or disable this feature. When enabled, a checkmark will appear in the checkbox and the occupancy sensor will power-off the display when the room is no longer occupied.
8. Enter the IP address of the occupancy sensor in the **IP** field.
9. Enter the port number in the **Port** field. The default port setting is 9000.



IMPORTANT: When adding an occupancy sensor, it is recommended that a static IP address is assigned to the occupancy sensor. DHCP is not recommended.

10. Click the **Connect** button to connect to the occupancy sensor. All connected occupancy sensors will appear under the **Sensors** section, as shown below.
11. Click the **Identify** button to identify the occupancy sensor. This feature is useful when multiple sensors are connected. See *Example A* below.



NOTE: Both the AT-OME-MS52W and AT-UHD-SW-510W support a maximum of three AT-OCS-900N devices.

12. Click the **Remove** button to delete a sensor from the **Sensors** list.
13. Setup is complete.

Occupancy Sensor Control

Turn Display On on Occupancy

Turn Display Off on Vacancy

IP

Port

Sensors

Status	IP		
Connected!	10.1.0.24:9000	<input type="button" value="Identify"/>	<input type="button" value="Remove"/>

Example A - Multiple occupancy sensors added to the AT-OME-MS52W / AT-UHD-SW-510W.

Sensors

Status	IP		
Connected!	10.1.0.25:9000	<input type="button" value="Identify"/>	<input type="button" value="Remove"/>
Connected!	10.1.0.24:9000	<input type="button" value="Identify"/>	<input type="button" value="Remove"/>

Integration with AT-OME-MS42



NOTE: The AT-OME-MS42 supports a maximum of three AT-OCS-900N devices.

The following provides instructions on adding the AT-OCS-900N occupancy sensor as a device. The **AutoSwitch** feature on the AT-OME-MS42 does not need to be enabled for this to work.



IMPORTANT: A username and password must be configured on the AT-OCS-900N before using the device with the AT-OME-MS42.

1. Connect the AT-OCS-900N to the same network as the AT-OME-MS42. Refer to the AT-OCS-900N User Manual for more information.
2. Login to the web server of the AT-OME-MS42.
3. Click **Display** in the top menu bar.
4. Under the **Occupancy Sensor Control** section, enter the IP address of the AT-OCS-900N in the **IP Address** field.

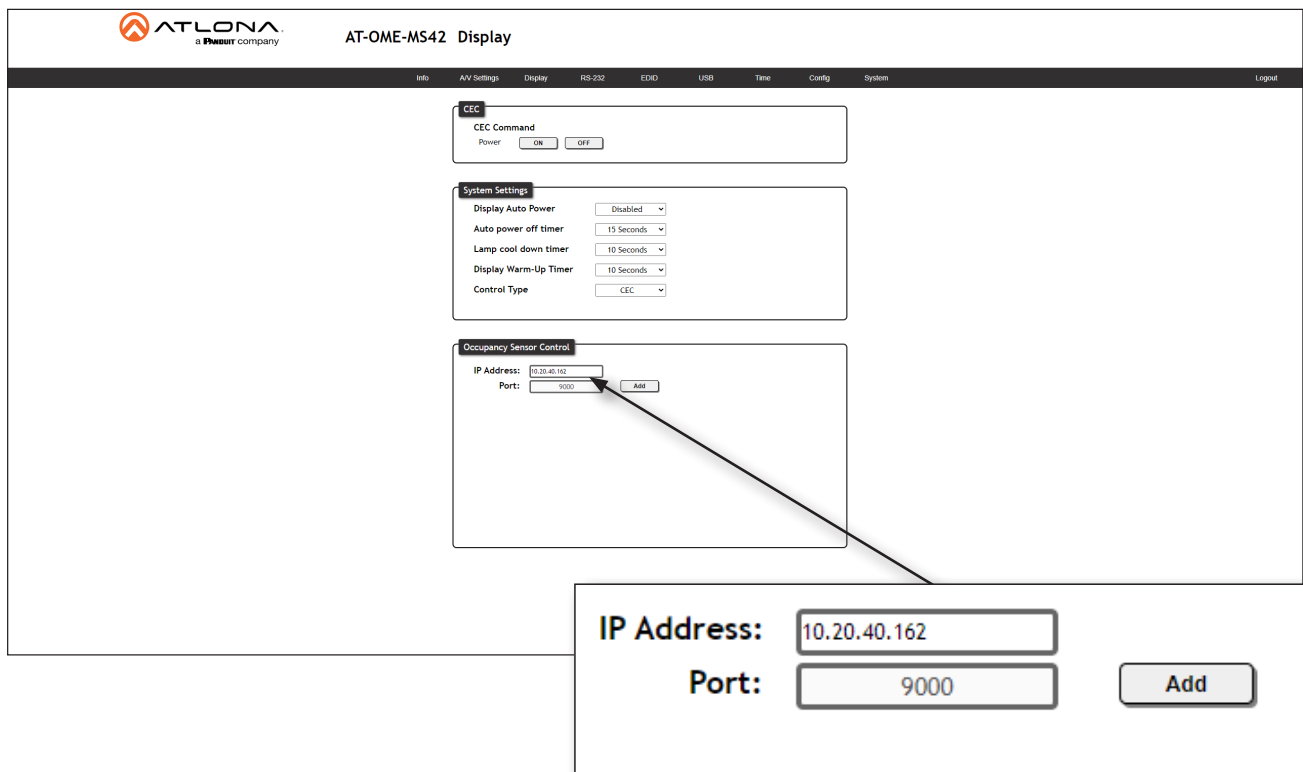

The screenshot shows the AT-OME-MS42 web interface. The top navigation bar includes 'Info', 'AV Settings', 'Display', 'RS-232', 'EDID', 'USB', 'Time', 'Config', 'System', and 'Logout'. The main content area is divided into three sections: 'CEC Command' with a 'Power' toggle (ON/OFF), 'System Settings' with dropdown menus for 'Display Auto Power' (Disabled), 'Auto power off timer' (15 Seconds), 'Lamp cool down timer' (10 Seconds), 'Display Warm-Up Timer' (10 Seconds), and 'Control Type' (CEC). The 'Occupancy Sensor Control' section contains an 'IP Address' field (10.20.40.162) and a 'Port' field (9000) with an 'Add' button. A callout box provides a magnified view of these fields.

5. Click the **Add** button. If the correct IP address was entered and the AT-OCS-900N is found, additional information will be displayed under the Occupancy Sensor Control section, as shown on the next page.

IP Address:

Port:

[10.20.40.162](#)

Turn Display On on Occupancy

Turn Display Off on Vacancy

6. Click the **Turn Display On on Occupancy** toggle to enable or disable this feature. When enabled, the toggle switch will display as **ENABLED** and the occupancy sensor will power-on the display when the room is occupied.
7. Click the **Turn Display Off on Vacancy** toggle to enable or disable this feature. When enabled, the toggle will display as **ENABLED** and the occupancy sensor will power-off the display when the room is no longer occupied.
8. Click the **Identify** button to identify the occupancy sensor. This feature is useful when multiple sensors are connected.



IMPORTANT: When adding an occupancy sensor, it is recommended that a static IP address is assigned to the occupancy sensor. DHCP is not recommended.

9. Click the **Remove** button to delete a sensor from the **Sensors** list.
10. Setup is complete.

Specifications

Motion Sensor	
Detection	PIR (Passive Infrared)
Coverage Area	900 ft ² (83.6 m ²), 2000 ft ² (185.8 m ²) with accessory lens
Coverage Pattern	360°

Ambient Light Sensor	
Range	0 to 65535 lux
Color Spectrum	RGBW, 16-bit

Temperature Sensor	Fahrenheit	Celsius
Range	-40 to +257	-40 to +125
Measurement System	Celsius, Fahrenheit, ADC	

Ethernet	
Port	1 x RJ45
Standards and Protocols	MQTT, JSON over WebSocket, mDNS, HTTP/TLS, TCP, UDP
Speeds	10/100 Mbps
Addressing	DHCP, Static

LED Indicators	
Motion Detection	4 - LED, configurable (inner/outer illumination)

Connectors	
LAN	1 - RJ45, female

Environmental	Fahrenheit	Celsius
Operating	+32 to +122	0 to +50
Storage	-40 to +158	-40 to +70
Humidity (RH)	90% (maximum), non-condensing	

Power	
Consumption	1.1 W
PoE	802.3af

Dimensions (H x DIA)	Inches	Millimeters
Unit	2.13 x 2.90	54 x 74

Weight	Ounces	Grams
Device	2.11	60

Certification	
Device	CE, FCC, UL 916 file no. #E524557, UKCA

Compliance	
NDAA-899	Yes

Warranty	
Device	To view the product warranty, use the following link: https://atlon.com/warranty

