

Velocity Keypad

AT-VKP-8E-EU



The Atlona AT-VKP-8E-EU is a simple yet powerful 8 button IP-based control system in a wallplate form factor. The buttons are fully configurable for controls such as display power, input switching, audio levels, or any other functions supported by system devices. In addition to Ethernet, the VKP-8E-EU also features RS-232 for control of legacy devices. For enhanced customization, the VKP-8E-EU incorporates a 2.7" e-ink display that supports multiple pages to dynamically change icons and text associated with the buttons. LED indicators for each button and a multi-step LED level indicator provide additional feedback to users. The VKP-8E-EU is designed to mount in one-gang EU/UK junction boxes and comes with both black and white faceplates that attach to the button panel via magnets. Power over Ethernet (PoE) provides both power and data to the panel over a single cable. For setup, the VKP-8E-EU uses a revolutionary new configuration platform called Atlona Cloud. It provides an intuitive interface for mapping control commands, text, and icons to buttons using the extensive library of Atlona and third-party device drivers. When configuration is complete, lightweight instructions can either be sent to the VKP-8E-EU directly over the network or stored in a file for later upload.

Package Contents

- | | |
|-----------------------------------|------------------------|
| 1 x AT-VKP-8E-EU | 2 x Face plate screws |
| 1 x White faceplate | 1 x Installation Guide |
| 1 x 3-pin Captive Screw Connector | |
| 2 x Mounting screws | |



IMPORTANT: The unit can be set up locally, but the computer used for configuration must have an external connection.

Panel Descriptions

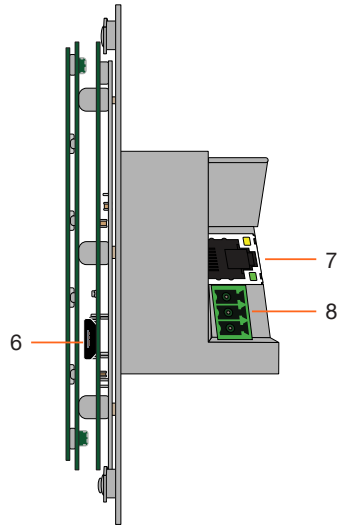
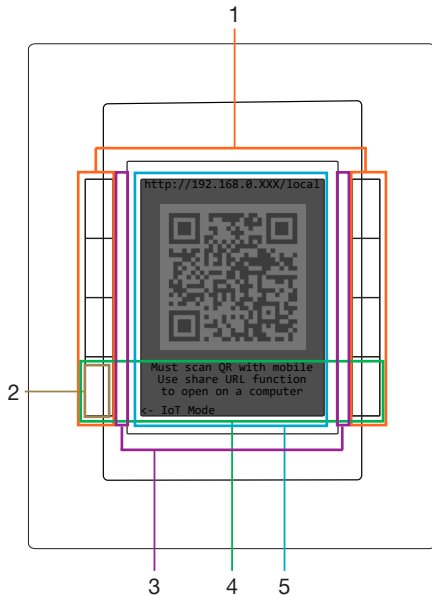

- | | |
|---|--|
| <p>1 Control Buttons
Once set up, use the buttons to trigger the control commands.</p> <p>2 E-ink Display
Displays the connection and start up information, along with button icons and text as set inside cloud configuration</p> <p>3 Mode Button
During set up, use the bottom left button to switch between Internet of Things (IoT) and Local mode.</p> <p>4 Volume LEDs
LED indicators that display volume level feedback.</p> <p>5 Settings Buttons
Press and hold the bottom two buttons to switch to additional settings options for the VKP.</p> | <p>6 Button LEDs
These can be set to display multiple colors within the settings to provide status.</p> <p>7 Service Port
This port is used by Technical Support and is not for users.</p> <p>8 LAN
Connect an Ethernet cable to this port for power and control/configuration.</p> <p>9 RS-232 Port
Connect the included 3-pin captive screw connector to this port then to the control device.</p> |
|---|--|

RS-232

A 3-pin captive screw connector has been included for RS-232.

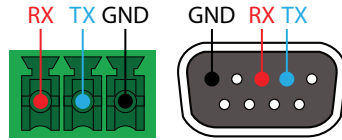
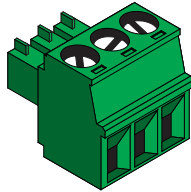

Pin out will be determined by the RS-232 cable and connect as RX (receive), TX (transmit) and \perp (Ground).

Mounting Instructions

The AT-VKP-8E-EU can be mounted to a 1-gang back box.

- 1 Select the type of 1-gang back box to use and install into a wall.



NOTE: Install using the region's safety guidelines for electrical boxes.

- 2 Thread the Ethernet cable through the 1-gang box.



- 3 *Optional* Run the RS-232 connector and cable through the wall and back box.
- 4 Remove the faceplate from the front of the VKP-8E-EU. The faceplate is attached using magnets, so simply grab the faceplate from the sides and pull it off the unit.
- 5 Remove the four screws from the top and bottom of the unit (circled to the right) and pull the mounting plate from the unit (shown below).

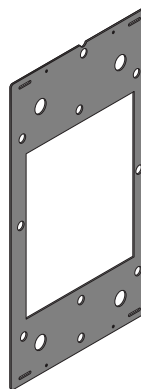
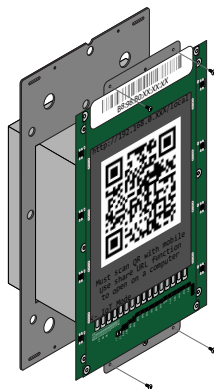
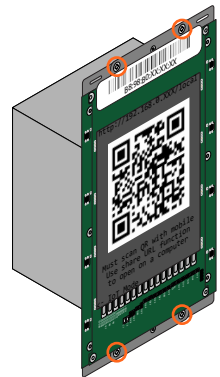

- 6 Thread the Ethernet cable through the mounting plate.
- 7 Install the mounting plate into the wall, using the two of the included mounting screws.
EU - Thread the screws through the top and bottom, as pictured below.
UK - Thread the screws through the middle two screws, as pictured below.

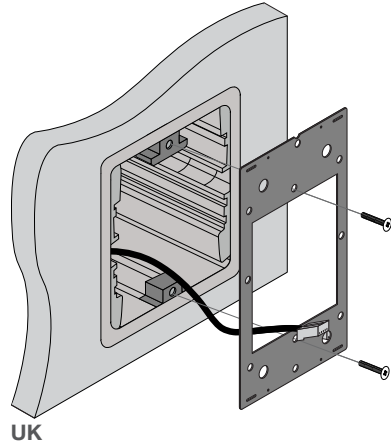
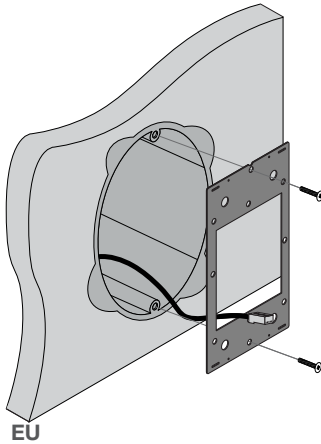

- 8 Connect the Ethernet cable (and/or *optional* RS-232 connector) to the LAN port (and RS-232 port) on the back of the unit.
- 9 Install the unit into the back box, securing it using the 4 screws removed earlier through the 4 holes in the unit and mounting plate.

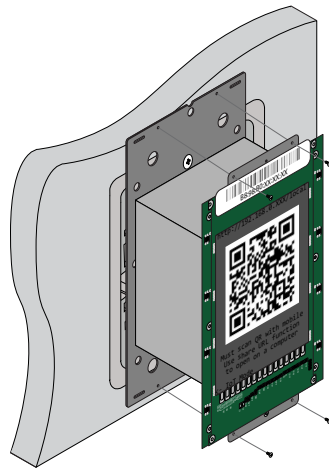
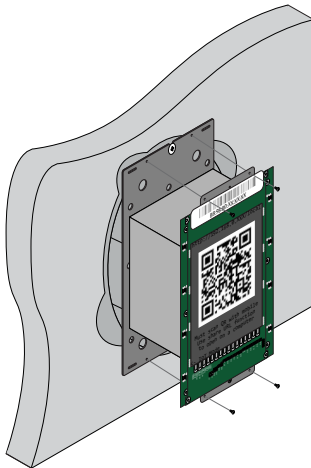

- 10 Once secured to the wall, place the front face plate back onto the unit. The magnets will secure it in place.

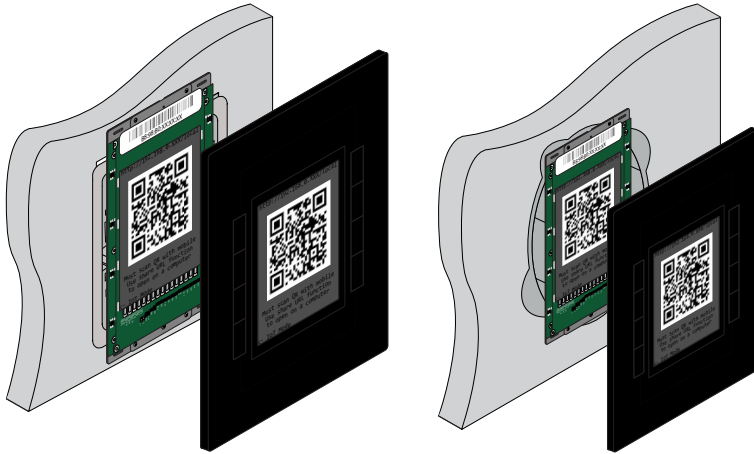

- 11 *Optional* To ensure the face plate stays in place, use the included face plate screw and thread it through the bottom of the face plate (an extra screw is included in case one is lost).
The unit is fully installed.

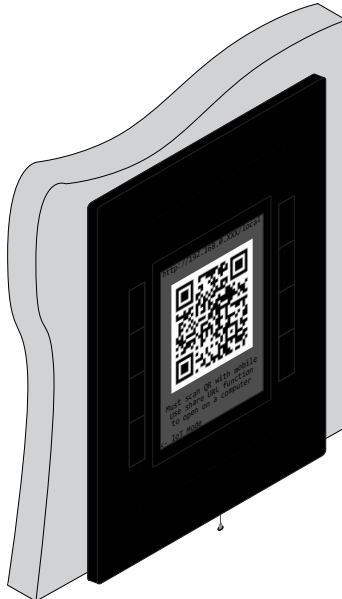

Initial VKP Setup

The AT-VKP-8E-EU has two modes for set up: Local and IoT (Internet of Things - recommended). No matter which mode is set on the AT-VKP-8E-EU, the computer doing the configuration must be connected to the Internet.



NOTE: If the local network is not recognizing or speaking to the unit, ensure that port 443 (https) is enabled. If port 443 is disabled, the unit may not speak correctly across the network.

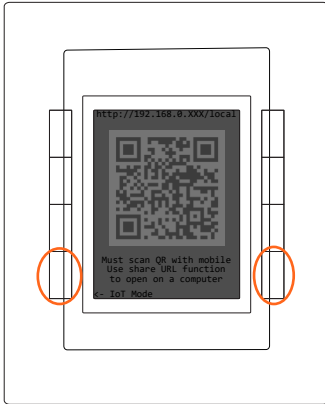

For easy network configuration, press and hold the bottom left & right buttons for 2 seconds. Once released, it will open an advanced options screen.

From here, the unit can be changed from DHCP to Static IP modes by pressing the corresponding buttons to the mode. It may take 5-10 seconds to switch IPs, the IP will display at the top. Static IP will set the unit to 192.168.0.231.

The unit can be switched between Local and IoT Mode using the bottom buttons, this will take the unit out of advanced mode.

The unit can be factory reset (does not unregister the unit) and reboot from advanced mode if needed.

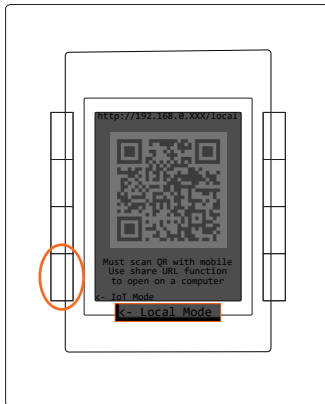
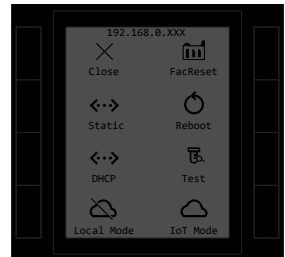

Modes can also be switched by pressing the bottom left hand button from the main screen.

Local Mode

Local mode will make the local webUI available to do some basic unit configuration. Scan the QR code or type in the ip address located at the top of the unit (ex 192.168.0.xxx/local) to access the webUI of the unit. This will allow for uploading and downloading configuration files to the unit, firmware updating, changing network settings, and more.

While local mode allows for basic unit configuration, control configuration will still need to be done online, with the config file being uploaded manually to the unit in the webUI, rather than synced through the cloud.

IoT Mode (recommended)

IoT mode sets the unit to be updated through the cloud configurator whenever a change is made or a firmware update is received.

Both modes will have control configured through <https://cloud.atlona.com>. To get to the configuration, scan the QR code (when in IoT Mode) on a phone, tablet, etc, type the IP address of the unit listed at the top of the e-ink display (minus /local in Local Mode), click the Open Cloud button when in the local webUI (in local mode), or simply enter <https://cloud.atlona.com> into a browser. All options will lead to <https://cloud.atlona.com>.



NOTE: The IP address will only redirect if the unit and the PC for configuration are connected to the same network.

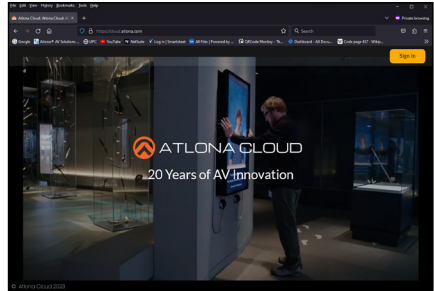
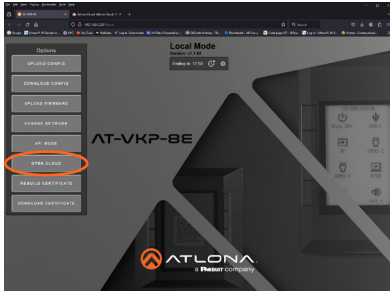

Once <https://cloud.atlona.com> page has been opened. It may take a few seconds to load until the login screen appears. Select the login button in the top right corner of the page. A pop up will appear.

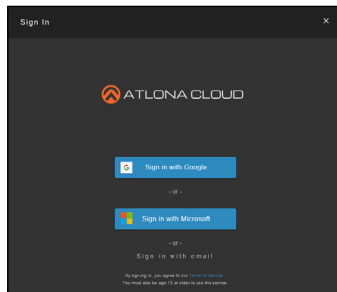

There are three options to login: Sign in with Google, Sign in with Microsoft, or Sign in with email.

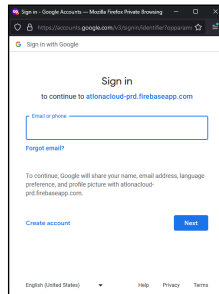
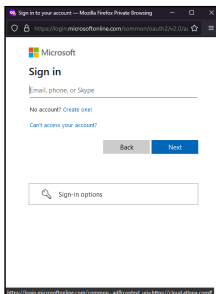

When selecting Google or Microsoft, a pop up will appear. Enter the account information and it will send a confirmation email.

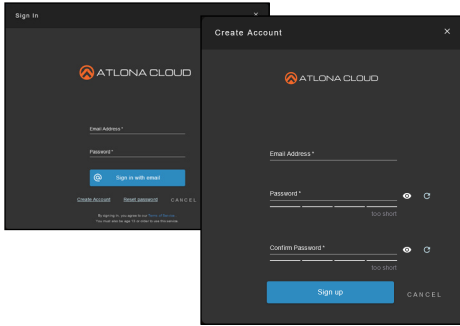

Sign in with email will require an email and password that has already been set up, if one has not been created, select the Create Account link below the blue button, a new screen will open. Once an email and password has been added, select the Sign up button. Once the account has been created, a confirmation email or text message will be sent (based on account settings) to verify the account.

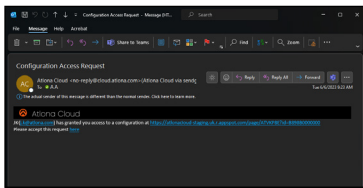

An email will be sent from the address no-reply@cloud.atlona.com. If it does not appear in the inbox within 5 minutes, check the Junk/Spam folder.

Select the here link to be redirected to a verify page.

The account is now ready for configuration.

When logging in the first time, if the unit has internet disabled, it will have a blank configuration page and the unit will have to be added manually. If the unit is in IoT mode, it will automatically link and register the unit.

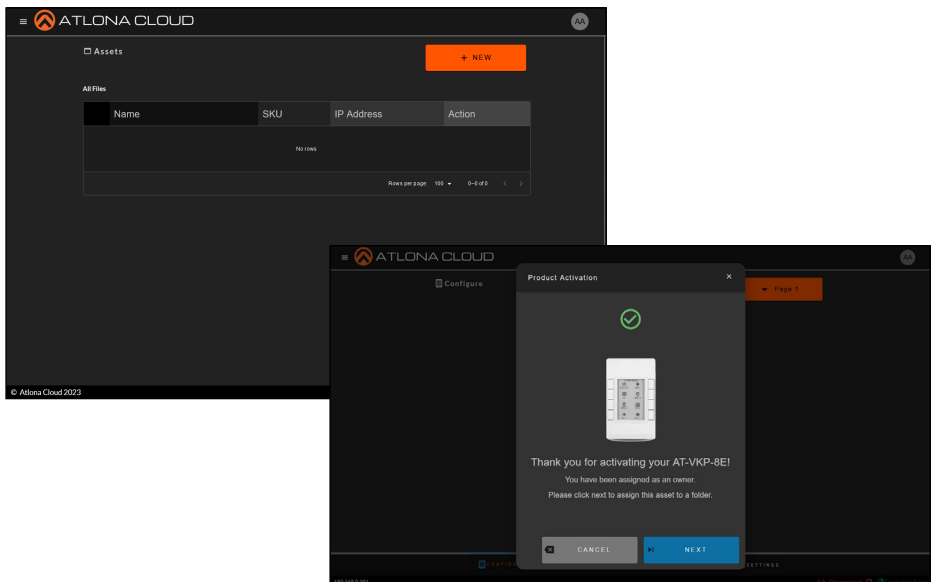

The unit is now ready for configuration. View the manual located in the resource tab of <https://atlona.com/product/at-vkp-8e-eu/> for full instructions on setting up the VKP-8E-EU.



Warranty

To view the product warranty, use the following link or QR code:

<https://atlona.com/warranty/>.



English Declaration of Conformity

The English version can be found under the resources tab at:

<https://atlona.com/product/at-vkp-8e-eu/>.



Chinese Declaration of Conformity 中国RoHS合格声明

由SKU列出於:

<https://atlona.com/about-us/china-rohs/>.



US International
atlona.com • 408.962.0515 • 41.43.508.4321